

# SELF-PROPELLED ROUGH-TERRAIN SCISSOR LIFTS

## OPERATOR'S MANUAL

*with Maintenance Information*

( For JCPT1523DC / JCPT1823DC )



### WARNING

THE MANUFACTURER SHALL NOT BE HELD LIABLE IN CASE OF FAULTS OR ACCIDENTS DUE TO NEGLIGENCE, INCAPACITY, INSTALLATION BY UNQUALIFIED TECHNICIANS AND IMPROPER USE OF THE MACHINE

DO NOT OPERATE THIS MACHINE UNTIL YOU READ AND UNDERSTAND ALL THE DANGERS, WARNINGS AND CAUTIONS IN THIS MANUAL

Part Number: SM0121121\_Rev1.0



Zhejiang Dingli Machinery Co., Ltd.

First Edition, April 2021

# Version of the Record

## Version of the Record

Version Number	Create Date
SM0121121_Rev1.0 .....	2021-06



## Important

Read, understand and obey these safety rules and operating instructions before operating this machine.

Only trained and authorized personnel shall be permitted to operate this machine. This manual should be considered a permanent part of your machine and should remain with the machine at all times. If you have any questions, please call DINGLI Machinery.

## Contents

---

	Page
Safety Rules	1
Legend	8
Decals	9
Specifications	14
Control panel	16
Pre-operation Inspection	20
Workplace Inspection	22
Function Tests	23
Operating Instructions	28
Transport and Lifting Instructions	32
Maintenance	35
Schematic	57
Inspection and Repair Log	61

---

## Owners, Users and operators:

We appreciate your choice of our machine for your application. Our number one priority is user safety, which is best achieved by our joint efforts. We feel that you make a major contribution to safety if you, as the equipment users and operators:

- 1 Comply with employer, job site and governmental rules.
- 2 Read, understand and follow the instructions in this and other manuals supplied with this machine.
- 3 Use good safe work practices in a commonsense way.
- 4 Only have trained / certified operators, directed by informed and knowledgeable supervision, running the machine.

If there is anything in this manual that is not clear or which you believe should be added, please contact us.

---

## Contact us:

---

### Zhejiang Dingli Machinery Co., Ltd.

1255 Baiyun South Road. Leidian Town.  
Deqing Zhejiang

China

Tel: +86-572-8681688

Fax: +86-572-8681690

Web: [www.cndingli.com](http://www.cndingli.com)

E-mail: [market@cndingli.com](mailto:market@cndingli.com)





## Danger

Failure to obey the instructions and safety rules in this manual will result in death or serious injury.

## Do Not Operate Unless:

- You learn and practice the principles of safe machine operation contained in this operator's manual.
  - 1 **Avoid hazardous situations.**

**Know and understand the safety rules before going on to the next section.**

    - 2 Always perform a pre-operation inspection.
    - 3 Always perform function tests prior to use.
    - 4 Inspect the workplace.
    - 5 Only use the machine as it was intended.
- You read, understand and obey the manufacturer's instructions and safety rules— safety and operator's manuals and machine decals.
- You read, understand and obey employer's safety rules and worksite regulations.
- You read, understand and obey all applicable governmental regulations.
- You are properly trained to safely operate the machine.

## Decal Legend

DINGLI product decals use symbols, color coding and signal words to identify the following:



**Safety alert symbol**—used to alert personnel to potential personal injury hazards. Obey all safety messages that follow this symbol to avoid possible injury or death.

**⚠ DANGER** Red—used to indicate the presence of an imminently hazardous situation which, if not avoided, will result in death or serious injury.

**⚠ WARNING** Orange—used to indicate the presence of a potentially hazardous situation which, if not avoided, could result in death or serious injury.

**⚠ CAUTION** Yellow with safety alert symbol—used to indicate the presence of a potentially hazardous situation which, if not avoided, may cause minor or moderate injury.

**NOTICE** Blue without safety alert symbol—used to indicate the presence of a potentially hazardous situation which, if not avoided, may result in property damage.

## Safety Rules

### The relevant conditions of using the equipment

The surface of work ground should be flat and hard with no obstacles in air and the safety distance between the equipment and high-tension line is adequate.

The environment temperature should be within -20°C~40°C; Height above sea level ≤1000m.

The environment humidity ≤ 90%.

Electrical power: AC 110~230V±10%, 50~60Hz.

### Intended Use

This machine is intended to be used only to lift personnel, along with their tools and materials to an aerial work site.

### Safety Sign Maintenance

Replace any missing or damaged safety signs. Keep operator safety in mind at all times. Use mild soap and water to clean safety signs. Do not use solvent-based cleaners because they may damage the safety sign material.

### ⚠ Electrocution Hazard

This machine is not electrically insulated and will not provide protection from contact with or proximity to electrical current.

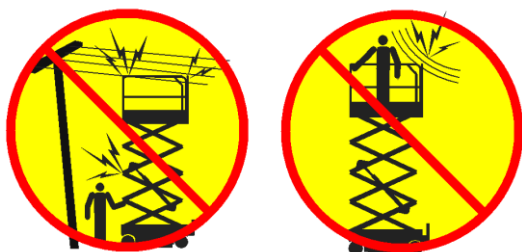

Maintain safe distances from electrical power lines and apparatus in accordance with applicable governmental regulations and the following chart.

Voltage Phase to Phase	Minimum Safe Approach Distance Meters
0 to 300V	Avoid Contact
300V to 50kV	3.05
50kV to 200kV	4.60
200kV to 350kV	6.10
350kV to 500kV	7.62
500kV to 750kV	10.67
750kV to 1000kV	13.72

Allow for platform movement, electrical line sway or sag and beware of strong or gusty winds.

Keep away from the machine if it contacts energized power lines. Personnel on the ground or in the platform must not touch or operate the machine until energized power lines are shut off.

Do not operate the machine during lightning or storms.

Do not use the machine as a ground for welding.

### ⚠ Tip-over Hazard

Occupants, equipment and materials must not exceed the maximum platform capacity or the maximum capacity of the platform extension.

#### Maximum capacity – JCPT1523DC

Maximum occupants 7

#### Models with one extension deck

Platform allowable maximum load 680kg

Extension deck allowable maximum load 227kg

Only Extension deck		Only platform
227kg		453kg

## Safety Rules

### Models with two extension deck

Platform allowable maximum load		680kg
For each extension deck		227kg
Only Extension deck		Only Extension deck
227kg	226kg	227kg

### Maximum capacity – JCPT1823DC

Maximum occupants	4
-------------------	---

### Models with one extension deck

Platform allowable maximum load	680kg
Extension deck allowable maximum load	227kg
Only Extension deck	
227kg	453kg

### Models with two extension deck

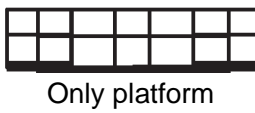
Platform allowable maximum load	680kg
For each extension deck	227kg
Only Extension deck	
227kg	226kg
	227kg

### Work Area Safety

Do not raise the platform unless the machine is on a firm, level surface.

Do not drive over 1.1 km/h with the platform raised.



Do not depend on the tilt alarm as a level indicator. The tilt alarm sounds on the chassis and in the platform when the machine is on a slope.

If the tilt alarm sounds:

Lower the platform. Move the machine to a firm, level surface. If the tilt alarm sounds when the platform is raised, use extreme caution to lower the platform.

For outdoor use machine, Do not raise the platform when wind speeds may exceed 12.5 m/s. If wind speeds exceed 12.5 m/s when the platform is raised, lower the platform and do not continue to operate the machine.

Do not operate the machine in strong or gusty winds. Do not increase the surface area of the platform or the load. Increasing the area exposed to the wind will decrease machine stability.



Do not use the platform controls to free a platform that is caught, snagged or otherwise prevented from normal motion by an adjacent structure. All personnel must be removed from the platform before attempting to free the platform using the ground controls.

Use extreme care and slow speeds while driving the machine in the stowed position across uneven terrain, debris, unstable or



## Safety Rules

slippery surfaces and near holes and drop-offs.

Do not drive the machine on or near uneven terrain, unstable surfaces or other hazardous conditions with the platform raised.

Do not push off or pull toward any object outside of the platform.



### Maximum allowable manual force

Model	Application	manual force	Maximum occupants
JCPT1523DC	Outdoor	400N	7
	Indoor	400N	7
JCPT1823DC	Outdoor	400N	4
	Indoor	400N	4

Do not use the machine as a crane.

Do not place or attach fixed or overhanging loads to any part of this machine.

Do not push the machine or other objects with the platform.

Do not contact adjacent structures with the platform.

Do not alter or disable the limit switches.

Do not tie the platform to adjacent structures.

Do not place loads outside the platform perimeter.



Do not alter or disable machine components that in any way affect safety and stability.

Do not replace items critical to machine stability with items of different weight or specification.

Do not modify or alter an aerial work platform without prior written permission from the manufacturer. Mounting attachments for holding tools or other materials onto the platform, toe boards or guard rail system can increase the weight in the platform and the surface area of the platform or the load.

Do not place ladders or scaffolds in the platform or against any part of this machine.

Do not transport tools and materials unless they are evenly distributed and can be safely handled by person(s) in the platform.

Do not use the machine on a moving or mobile surface or vehicle.

Be sure all tires are in good condition, air-filled tires are properly inflated and lug nuts are properly tightened.

### ▲ Crushing Hazard

Keep hands and limbs out of scissors.

Keep hands clear when folding rails.

Use common sense and planning when operating the machine with the controller from the ground. Maintain safe distances between the operator, the machine and fixed objects.

Maintain a firm grasp on the platform rail when removing the rail pins. Do not allow the platform guard rails to fall.

### ▲ Operation on Slopes Hazard

Do not drive the machine on a slope that exceeds the slope and side slope rating of the machine.

Slope rating applies to machines only in the stowed position.

## Safety Rules

Model	Maximum slope rating stowed position	Maximum side slope rating stowed position
JCPT1523DC	50% (26°)	50% (26°)
JCPT1823DC	40% (22°)	40% (22°)

Note: Slope rating is subject to ground conditions and adequate traction.

### ▲ Fall Hazard

The guard rail system provides fall protection. During operation, occupants in the platform must wear a full body harness with a lanyard attached to an authorized lanyard anchorage point. Attach only one (1) lanyard per lanyard anchorage point.

Do not sit, stand or climb on the platform guard rails. Maintain a firm footing on the platform floor at all times.

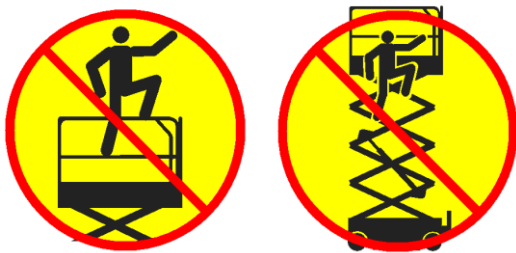

Do not climb down from the platform when raised.

Keep the platform floor clear of debris.

Close the entry gate before operating.

Do not operate the machine unless the guard rails are properly installed and the entry is secured for operation.

Do not enter or exit the platform unless the machine is in the stowed position.

### ▲ Collision Hazard

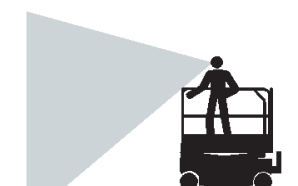

Be aware of limited sight distance and blind spots when driving or operating.

Be aware of extended platform position(s) when moving the machine.

Check the work area for overhead obstructions or other possible hazards.



Be aware of crushing hazards when grasping the platform guard rail.

Operators must comply with employer, job site and governmental rules regarding use of personal protective equipment.

Observe and use color-coded direction arrows on the platform controls and platform decal plate for drive and steer functions.

Do not operate a machine in the path of any crane or moving overhead machinery unless the controls of the crane have been locked out and/or precautions have been taken to prevent any potential collision.

No stunt driving or horseplay while operating a machine.

Do not lower the platform unless the area below is clear of personnel and obstructions.



Limit travel speed according to the condition of the ground surface, congestion, slope, location of personnel, and any other factors which may cause collision.

## Safety Rules

### ▲ Component Damage Hazard

Do not use any battery or charger greater than 48V to charge the battery.

Do not use the machine as a ground for welding.

### ▲ Explosion and Fire Hazards

Do not operate the machine in hazardous locations or locations where potentially flammable or explosive gases or particles may be present.

### ▲ Damaged Machine Hazard

Do not use a damaged or malfunctioning machine.

Conduct a thorough pre-operation inspection of the machine and test all functions before each work shift. Immediately tag and remove from service a damaged or malfunctioning machine.

Be sure all maintenance has been performed as specified in this manual. Be sure all decals are in place and legible.

Be sure the operator's manual is complete, legible and in the storage container located in the platform.

### ▲ Bodily Injury Hazard

Always operate the machine in a well-ventilated area to avoid carbon monoxide poisoning.

Do not operate the machine with a hydraulic oil or air leak. An air leak or hydraulic leak can penetrate and/or burn skin.

Improper contact with components under any cover will cause serious injury. Only trained maintenance personnel should access compartments. Access by the operator is only advised when performing a pre-operation inspection. All compartments must remain

closed and secured during operation.

### ▲ Outrigger Safety

Do not lower the outriggers unless the machine is on a firm surface. If the ground does not meet the requirements specified of the relevant regulations, sufficient ground preparation shall be carried out in advance to confirm its safety before operation. Avoid drop-offs, holes, unstable or slippery surfaces and other possible hazardous conditions.

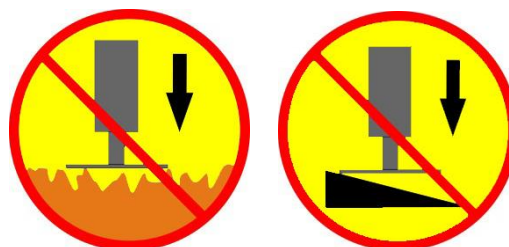

In case of special (soft or inclined) ground, the wood or steel pad suitable for the ground must be used under the support plate, and it must be firm and not cave in during the operation.

When using the backing plate, the backing plate must be of a solid structure that can fully withstand the pressure of the supporting leg. If the steel plate is set under the support plate, it should be used with small deformation.

When the auto level function is not being used and the outriggers are being lowered individually, the steer-end outriggers must be lowered first.

Do not raise the platform unless the machine is level. Do not set the machine up on a surface where it cannot be leveled using only the outriggers.

Do not raise the platform unless all four outriggers are properly lowered, the footpads are in firm contact with the ground and the machine is level.

Do not adjust the outriggers while the platform is raised.

## Safety Rules

Do not drive while the outriggers are lowered.

### ⚠ Battery Safety

#### ⚠ Burn Hazard



Batteries contain acid. Always wear protective clothing and eye wear when working with batteries.

Avoid spilling or contacting battery acid. Neutralize battery acid spills with baking soda and water.

#### ⚠ Explosion Hazard



Keep sparks, flames and lighted tobacco away from batteries. Batteries emit explosive gas.

#### ⚠ Electrocution/ Hazard

Avoid contact with electrical terminals.

#### ⚠ Pollute Hazard

Dispose of old battery must comply with job site and governmental rules.

### Lockout after Each Use

- 1 Select a safe parking location - firm level surface, clear of obstructions and traffic.
- 2 Lower the platform.
- 3 Turn the key switch to the off position and remove the key to secure from unauthorized use.
- 4 Push in the red Emergency Stop buttons to "off" position.
- 5 Push in the main power switch to "off" position
- 6 Chock the wheels.

# Legend

## Legend

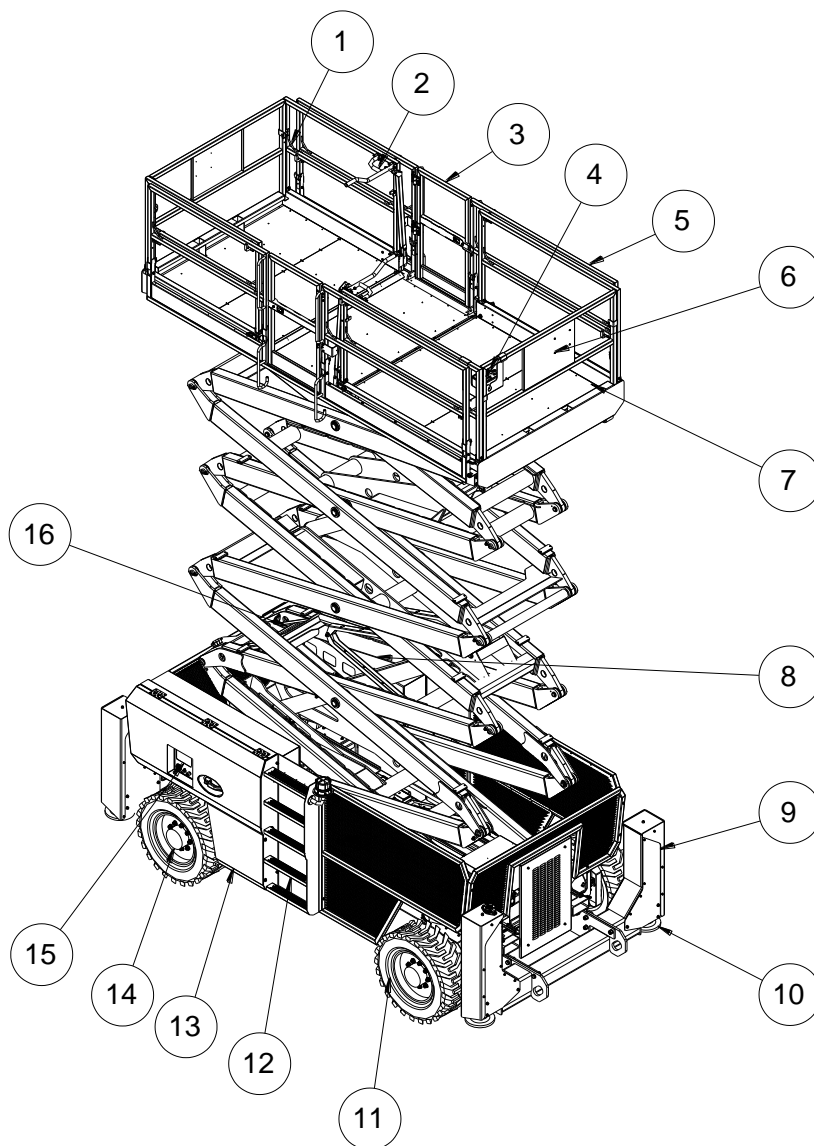

- |                                  |                                  |
|----------------------------------|----------------------------------|
| 1 Lanyard anchorage point        | 9 Outrigger housing              |
| 2 Platform extension lock handle | 10 Outrigger footpads            |
| 3 Platform entry gate            | 11 Steer tire                    |
| 4 Platform controls              | 12 Entry ladder                  |
| 5 Platform guard rails           | 13 Batteries tray (behind cover) |
| 6 Manual storage containers      | 14 Non-steer tires               |
| 7 Platform extensions            | 15 Ground controls               |
| 8 Hydraulic tanks (behind cover) | 16 Safety arm (hidden from view) |

**Decal Inspection**

Use the pictures on the next page to verify that all decals are legible and in place.

Below is a numerical list with quantities and descriptions.

<b>No.</b>	<b>Part No.</b>	<b>Description</b>	<b>Qty.</b>	<b>Remark</b>
1	09340001	Decal, Notice-Keep the manual with the machine	1	
2	09440119	Decal, Danger-Tip-over hazard, tilt-alarm	2	
3	09440001	Decal, Danger-General safety rules	2	
4	09340003	Decal, Instructions-Refer the operator to the instructions for use	2	
5	09440059	Decal, Label-Lanyard anchorage point	16	
6	09430003	Decal, Danger-Keep away from moving parts	2	
7	09430001	Decal, Danger-Safety arm	2	
8	09310442	Decal, Instructions-Maximum wheel load 2710kg	4	For: JCPT1523DC
	09310443	Decal, Instructions-Maximum wheel load 3030kg	4	For: JCPT1823DC
9	09420005	Decal, Warning-Collision hazard	4	
10	09310050	Decal, Instructions-Tie down point	4	
11	09310049	Decal, Instructions-Lift point	4	
12	09410069	Decal, Warning-Crushing hazard, outrigger	4	
13	09410157	Decal, Symbols-Outrigger using warning	4	
14	09310444	Decal, Instructions-Maximum outrigger load 2710kg	4	For: JCPT1523DC
	09310445	Decal, Instructions-Maximum outrigger load 3030kg	4	For: JCPT1823DC
15	09310052	Decal, Instructions-Highest oil level	1	
16	09310053	Decal, Instructions-Lowest oil level	1	
17	09310146	Decal, Instructions-Hydraulic	1	
18	09540001	Decal, Label-CE	1	
19	09910007	Decal, Label-4x4	2	
20	09410001	Decal, Danger-Explosion/burn hazard	2	

**Decals**

No.	Part No.	Description	Qty.	Remark
21	09410071	Decal, Warning-Injection hazard	1	
22	09910006	Decal, Label-Cosmetic	1	
23	09410005	Decal, Danger-Do not alter or disable limit switch	1	
24	09440007	Decal, Caution-Max. manual force 400N	2	
25	09440075	Decal, Label-Capacity 680kg	2	For: JCPT1523DC
	09440369	Decal, Label-Capacity 680kg	2	For: JCPT1823DC
26	09640164	Decal, Cosmetic-JCPT1523DC	2	For: JCPT1523DC
	09640165	Decal, Cosmetic-JCPT1823DC	2	For: JCPT1823DC
27	09210001	Nameplate, Manufacturer serial number	1	
28	09410006	Decal, Notice-Main power switch operation	1	
29	09410003	Decal, Warning-Inspected and operation properly	1	
30	09910005	Decal, Label-Cosmetic	1	
31	09310217	Decal, Instructions-Power to platform	1	
32	09310219	Decal, Instructions-Battery charger	1	

# Decals

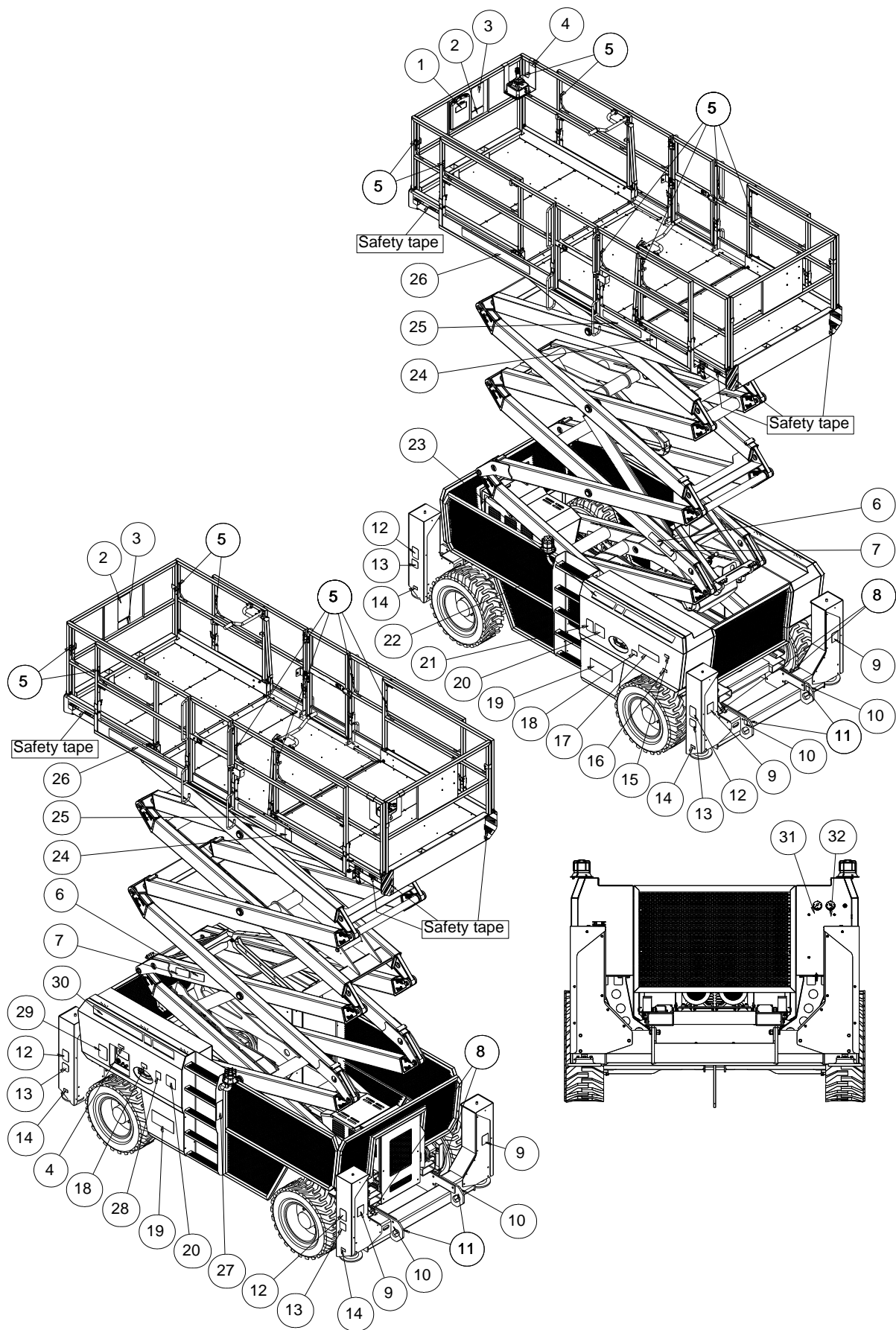



# Decals

① 09340001



② 09440119

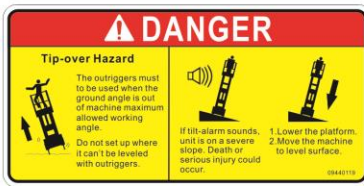

③ 09440001



④ 09340003

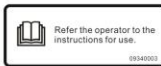

⑤ 09440059



⑧ 09310442



⑥ 09430003



⑧ 09310443



⑨ 09420005



⑦ 09430001



⑬ 09410157



⑮ 09310052



⑯ 09310053



⑩ 09310050



⑪ 09310049



⑫ 09410069



⑭ 09310444



⑭ 09310445

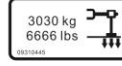

⑱ 09540001



⑰ 09310146



⑳ 09410071



㉑ 09910007



㉒ 09410001



㉓ 09410005



# Decals

23 09910006



25 09440075

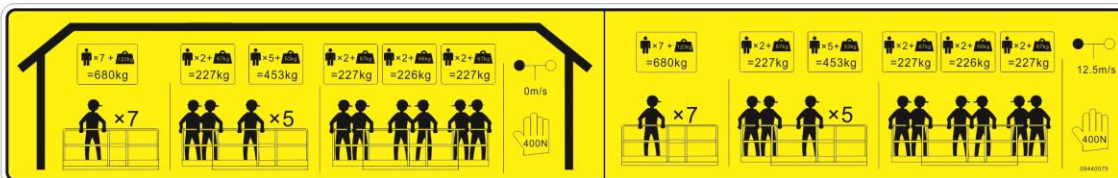

25 09440369

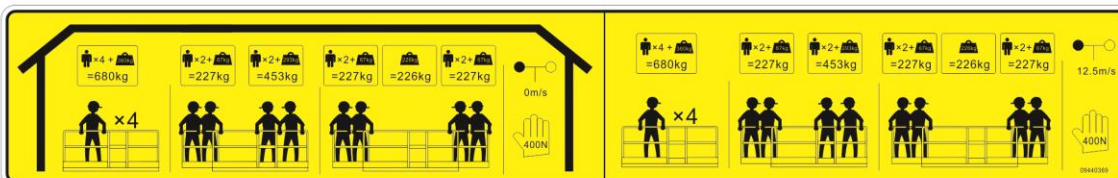

26 09640164

# JCPT1523DC

26 09640165

# JCPT1823DC

24 09440007



27 09210001

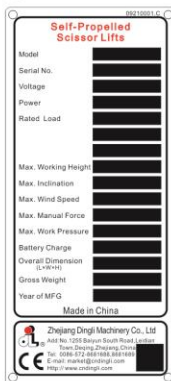

28 09310006

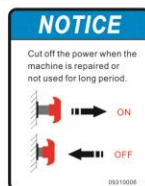

29 09410003

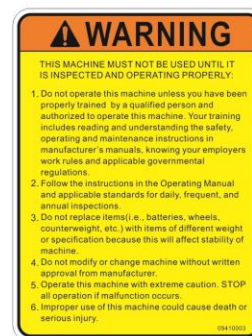

31 09310217



32 09310219



30 09910005



## Specifications

### Model JCPT1523DC

Height, working maximum	15m	Weight	See Serial Label
Height, platform maximum	13m	Machine weights vary with option configurations	
Height, stowed maximum Rails up	2.98m	Controls	Proportional
Height, stowed maximum Rails folded	2.28m	AC outlet in platform	Standard
Width, standard tires	2.29m	Maximum hydraulic pressure (functions)	240bar
Length, platform retracted Models with one extension deck	3.94m	Tire size - standard tires	33x12-20
Length, platform extended Models with one extension deck	5.4m	Airborne noise emissions	<80dB
Length, platform retracted Models with two extension decks	3.98m	Maximum sound level at normal operating workstations (A-weighted)	
Length, platform extended Models with two extension decks	6.6m	Gradeability	50%
Length, platform retracted Models with outriggers	4.88m	Maximum working slope	X-2°,Y-3°
Platform dimensions Platform length x width	3.98mx1.83m	<b>Drive speeds</b>	
Platform extension length	1.43m, 1.16m	Stowed, maximum	5.0km/h
Maximum load capacity	680kg	Platform raised, maximum	1.0km/h
Maximum wind speed	12.5m/s	<b>Floor loading information</b>	
Wheelbase	2.86m	Tire load, maximum	2710kg
Turning radius (outside)	5.2m	Outrigger load, maximum (if equipped)	2710kg
Turning radius (inside)	2.04m	Tire contact pressure	9.0kg/cm <sup>2</sup> 884.8kPa
Ground clearance	30cm	Occupied floor pressure	1033.8kg/m <sup>2</sup> 10.1kPa
Power source	375AH	Note: Floor loading information is approximate and does not incorporate different option configurations. It should be used only with adequate safety factors.	
System voltage	48V	Continuous improvement of our products is a policy. Product specifications are subject to change without notice or obligation.	

**Specifications****Model JCPT1823DC**

Height, working maximum	18m	Weight	See Serial Label
Height, platform maximum	16m	Machine weights vary with option configurations	
Height, stowed maximum Rails up	3.19m	Controls	Proportional
Height, stowed maximum Rails folded	2.49m	AC outlet in platform	Standard
Width, standard tires	2.29m	Maximum hydraulic pressure (functions)	240bar
Length, platform retracted Models with one extension deck	3.94m	Tire size - standard tires	33x12-20
Length, platform extended Models with one extension deck	5.4m	Airborne noise emissions	<80dB
Length, platform retracted Models with two extension decks	3.98m	Maximum sound level at normal operating workstations (A-weighted)	
Length, platform extended Models with two extension decks	6.6m	Gradeability	40%
Length, platform retracted Models with outriggers	4.88m	Maximum working slope	X-2°, Y-3°
Platform dimensions Platform length x width	3.98m x 1.83m	<b>Drive speeds</b>	
Platform extension length	1.43m, 1.16m	Stowed, maximum	5.0km/h
Maximum load capacity	680kg	Platform raised, maximum	1.0km/h
Maximum wind speed	12.5m/s	<b>Floor loading information</b>	
Wheelbase	2.86m	Tire load, maximum	3030kg
Turning radius (outside)	5.2m	Outrigger load, maximum (if equipped)	3030kg
Turning radius (inside)	2.04m	Tire contact pressure	9.0kg/cm <sup>2</sup> 884.8kPa
Ground clearance	30cm	Occupied floor pressure	1033.8kg/m <sup>2</sup> 10.1kPa
Power source	375AH	Note: Floor loading information is approximate and does not incorporate different option configurations. It should be used only with adequate safety factors.	
System voltage	48V	Continuous improvement of our products is a policy. Product specifications are subject to change without notice or obligation.	

# Control Panel

## Ground Control Panel

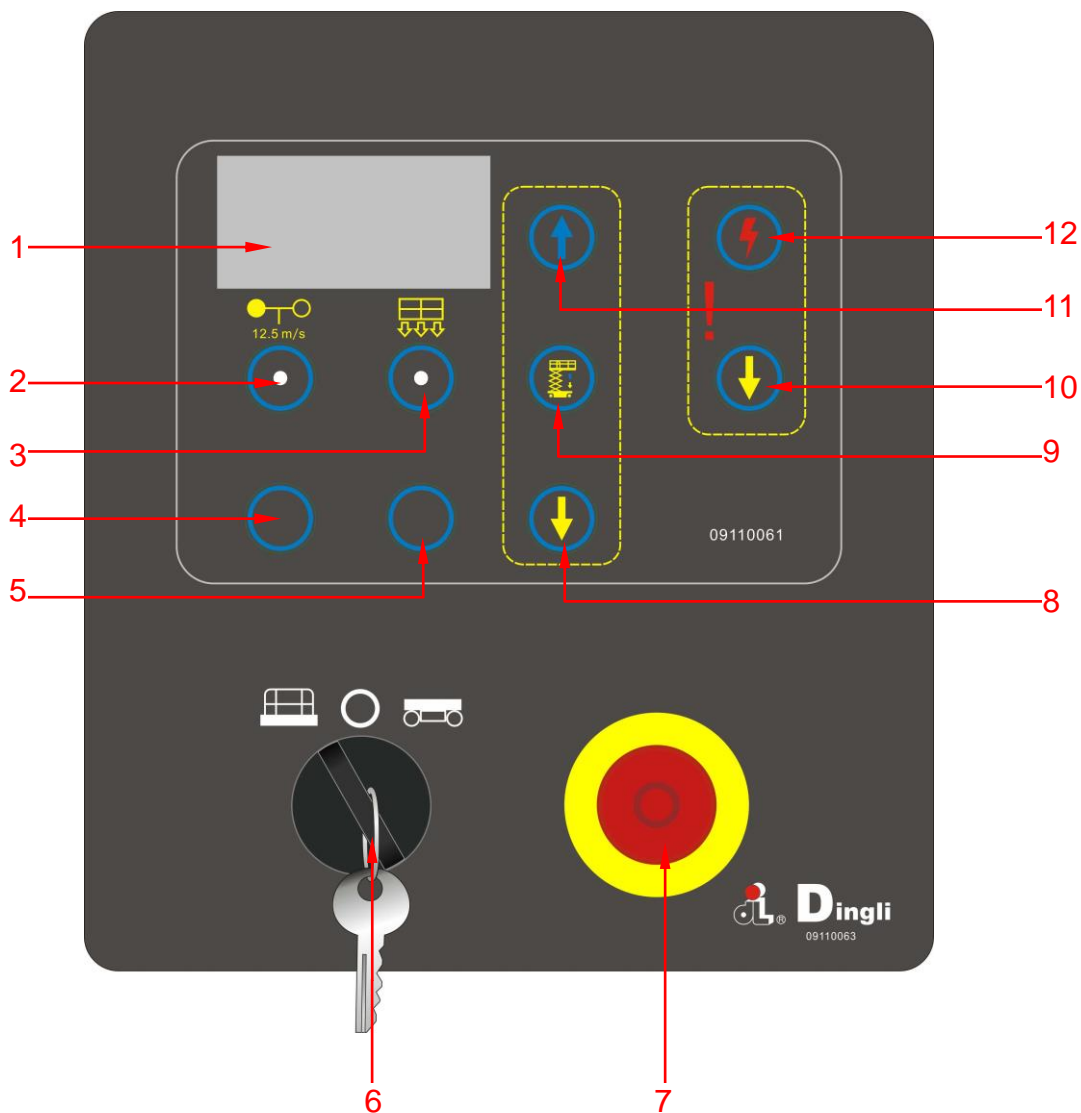

1 Display

2 Standby

3 Overload indicator light

4 Standby

5 Standby

6 Key switch

7 Red Emergency Stop button

8 Platform down button

9 Lift function enable button

10 Emergency lowering down button

11 Platform up button

12 Emergency lowering down enable button

## Control Panel

### Ground Control Panel

1 Display

Diagnostic readout

2 Standby

3 Overload indicator light

Light on indicates when overloaded.

4 Standby

5 Standby

6 Key switch

Turn the key switch to the platform position and the platform controls will operate.

Turn the key switch to the off position and the machine will be off. Turn the key switch to the base position and the ground controls will operate.

7 Red Emergency Stop button

Push in the red Emergency Stop button to the off position to stop all functions. Pull out the red Emergency Stop button to the on position to operate the machine.

8 Platform down button

Press this button and the platform will lower

9 Lift function enable button

Press this button to activate the lift function.

10 Emergency lowering down button

Press this button and the platform will lower

11 Platform up button

Press this button and the platform will lift.

12 Emergency lowering down enable button

Press this button to activate the Emergency down function.



## Control Panel

### Platform Controls

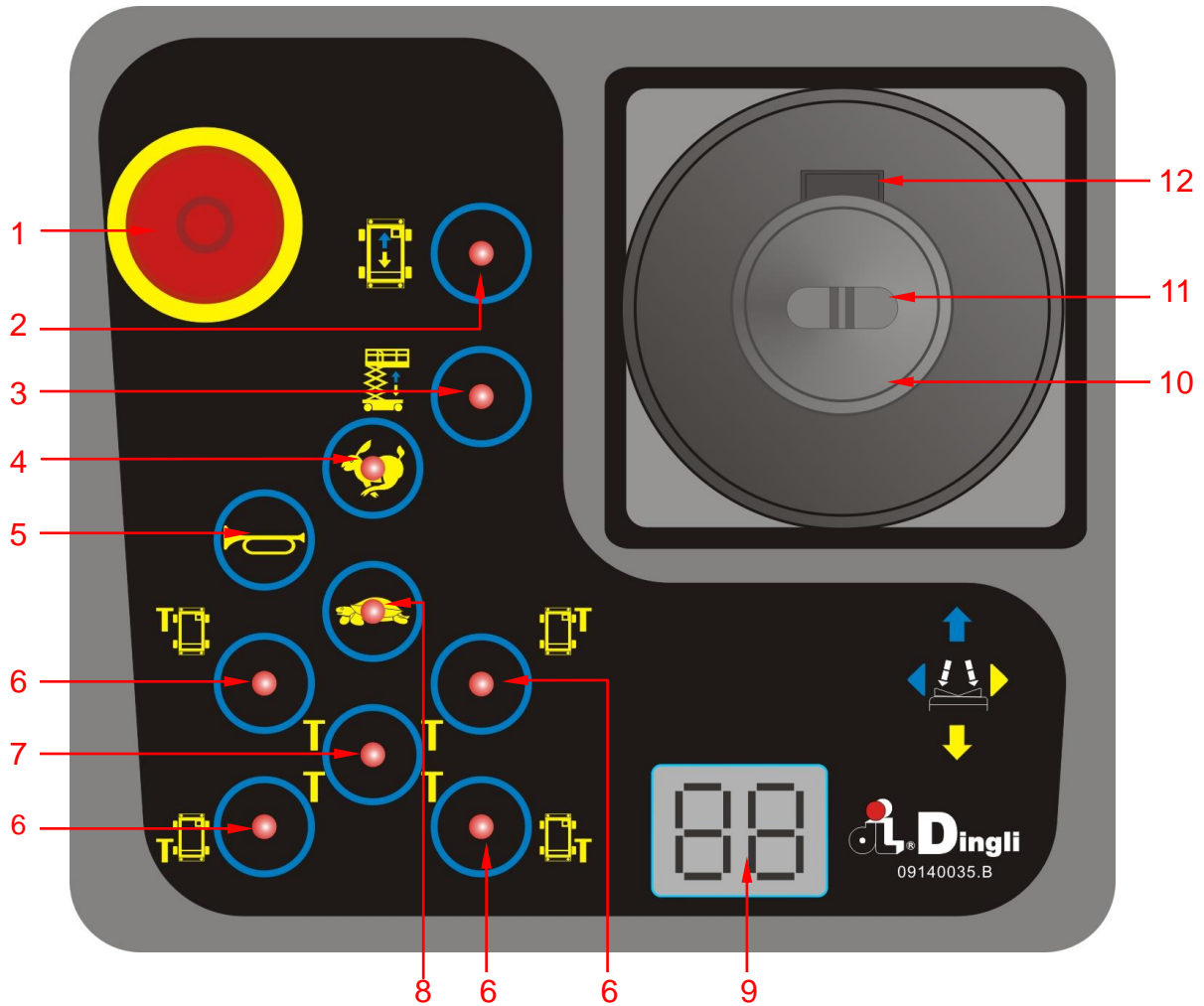

- 1 Red Emergency Stop button
- 2 Drive function select button
- 3 Lift function select button
- 4 High speed select button
- 5 Horn button
- 6 Outrigger function enable button

- 7 Outrigger auto level button
- 8 Torque speed select button
- 9 LED readout screen
- 10 Proportional control handle
- 11 Thumb rocker switch for steer function
- 12 Function enable switch

## Control Panel

### Platform Control Panel

1 Red Emergency Stop button

Push in the red Emergency Stop button to the off position to stop all functions. Pull out the red Emergency Stop button to the on position to operate the machine.

2 Drive function select button

Press this button to activate the drive function.

3 Lift function select button

Press this button to activate the lift function.

4 High speed select button

Press this button to activate the fast drive function.

5 Horn button

Press this button and the horn will sound.  
Release the button and the horn will stop.

6 Outrigger function enable button

Press this button to activate the individual outrigger up/down function.

7 Outrigger auto level button

Press this button to activate the auto level function.

8 Torque speed select button

Press this button to activate the slow drive function.

9 LED readout screen

Diagnostic readout.

10 Proportional control handle

Lift function: Press and hold the function enable switch to enable the lift function on the platform control handle. Move the control handle in the direction indicated by the blue arrow and the platform will raise. Move the control handle in the direction indicated by the yellow arrow and the platform will lower. The descent alarm should sound while the platform is lowering.

Drive function: Press and hold the function enable switch to enable the drive function on the platform control handle. Move the control handle in the direction indicated by the blue arrow on the control panel and the machine will move in the direction that the blue arrow points. Move the control handle in the direction indicated by the yellow arrow on the control panel and the machine will move in the direction that the yellow arrow points.

Outrigger extendable / retractable function: Press and hold the function enable switch to enable the Outrigger extend/ retract function on the platform control handle. Move the control handle in the direction indicated by the yellow arrow and the outrigger will extend. Move the control handle in the direction indicated by the blue arrow and the outrigger will retract.

11 Thumb rocker switch

Press the thumb rocker switch in either direction to activate steer function.

12 Function enable switch

Press and hold the function enable switch to enable the drive/lift function.



## Pre-operation Inspection



### Do Not Operate Unless:

You learn and practice the principles of safe machine operation contained in this operator's manual.

- 1 Avoid hazardous situations.
- 2 Always perform a pre-operation inspection.**

**Know and understand the pre-operation inspection before going on to the next section.**

- 3 Inspect the workplace.
- 4 Always perform function tests prior to use.
- 5 Only use the machine as it was intended.

### Fundamentals

It is the responsibility of the operator to perform a pre-operation inspection and routine maintenance.

The pre-operation inspection is a visual inspection performed by the operator prior to each work shift. The inspection is designed to discover if anything is apparently wrong with a machine before the operator performs the function tests.

The pre-operation inspection also serves to determine if routine maintenance procedures are required. Only routine maintenance items specified in this manual may be performed by the operator.

Refer to the list on the next page and check each of the items.

If damage or any unauthorized variation from factory delivered condition is discovered, the machine must be tagged and removed from service.

Repairs to the machine may only be made by a qualified service technician, according to the manufacturer's specifications. After repairs are completed, the operator must perform a pre-operation inspection again before going on to the function tests.

Scheduled maintenance inspections shall be performed by qualified service technicians, according to the manufacturer's specifications and the requirements listed in this manual.

## Pre-operation Inspection

### Pre-operation Inspection

- Be sure that the operator's manual are complete, legible and in the storage container located in the platform.
- Be sure that all decals are legible and in place. See Decals section.
- Check for hydraulic oil leaks and proper oil level. Add oil if needed. See Maintenance section.
- Check for battery fluid leaks and proper fluid level. Add distilled water if needed. See Maintenance section.

Check the following components or areas for damage, improperly installed or missing parts and unauthorized modifications:

- Electrical components, wiring and electrical cables
- Hydraulic hoses, fittings, cylinders and manifolds
- Battery pack and connections
- Drive motors
- Wear pads
- Tires and wheels
- Ground strap
- Limit switches, alarms and horn
- Nuts, bolts and other fasteners
- Platform overload components
- Platform entry gate
- Beacon (if equipped)
- Safety arm
- Platform extension(s)
- Scissor pins and retaining fasteners
- Platform control joystick
- Brake release components
- Pothole guard

Check entire machine for:

- Cracks in welds or structural components
- Dents or damage to machine
- Be sure that all structural and other critical components are present and all associated fasteners and pins are in place and properly tightened
- Be sure side rails are installed and rail pins and bolts are fastened.
- Be sure that the chassis trays are closed and latched and the batteries are properly connected.

Note: If the platform must be raised to inspect the machine, make sure the safety arm is in place. See Operating Instructions section.

## Workplace Inspection



### Do Not Operate Unless:

You learn and practice the principles of safe machine operation contained in this operator's manual.

- 1 Avoid hazardous situations.
- 2 Always perform a pre-operation inspection.
- 3 Inspect the workplace.**

**Know and understand the workplace inspection before going on to the next section.**

- 4 Always perform function tests prior to use.
- 5 Only use the machine as it was intended.

### Fundamentals

The workplace inspection helps the operator determine if the workplace is suitable for safe machine operation. It should be performed by the operator prior to moving the machine to the workplace.

It is the operator's responsibility to read and remember the workplace hazards, then watch for and avoid them while moving, setting up and operating the machine.

### Workplace Inspection

Be aware of and avoid the following hazardous situations:

- Drop-offs or holes
- Bumps, floor obstructions or debris
- Sloped surfaces
- Unstable or slippery surfaces
- Overhead obstructions and high voltage conductors
- Hazardous locations
- Inadequate surface support to withstand all load forces imposed by the machine
- Wind and weather conditions
- The presence of unauthorized personnel
- Other possible unsafe conditions

## Function Tests



### Do Not Operate Unless:

You learn and practice the principles of safe machine operation contained in this operator's manual.

- 1 Avoid hazardous situations.
- 2 Always perform a pre-operation inspection.
- 3 Inspect the workplace.
- 4 **Always perform function tests prior to use.**

### Know and understand the function tests before going on to the next section.

- 5 Only use the machine as it was intended.

### Fundamentals

The function tests are designed to discover any malfunctions before the machine is put into service.

The operator must follow the step-by-step instructions to test all machine functions.

A malfunctioning machine must never be used. If malfunctions are discovered, the machine must be tagged and removed from service.

Repairs to the machine may only be made by a qualified service technician, according to the manufacturer's specifications.

After repairs are completed, the operator must perform a pre-operation inspection and function tests again before putting the machine into service.

## Function Tests

- 1 Select a test area that is firm, level and free of obstruction.
- 2 Be sure the battery pack is connected.
- 3 Turn on the main power

### At the Ground Controls

- 4 Pull out the platform and ground red Emergency Stop button to the on position.
  - 5 Turn the key switch to ground control.
  - 6 Observe the display on the ground controls.
- ⊙ Result: The display will come on and display SYSTEM READY.

### Test Emergency Stop

- 7 Push in the ground red Emergency Stop button to the off position.
- ⊙ Result: No functions should operate.
- 8 Pull out the red Emergency Stop button to the on position.

### Test Up/Down Functions and Function Enable

A buzzer with different sound frequency is controlled in central system. The descent alarm sounds at 60 beeps per minute. The descent delay alarm sounds at 180 beeps per minute. The alarm that goes off when the machine is not level sounds at 180 beeps per minute. An optional automotive-style horn is also available.

- 9 Do not press the lift function enable button. Press and hold the platform up/down button.
- ⊙ Result: No function should operate.
- 10 Press and hold the lift function enable button. Press and hold the platform up button.
- ⊙ Result: The platform should rise.
- 11 Press and hold the lift function enable

button. Press and hold the platform down button.

- ⊙ Result: The platform should lower the descent alarm should sound while the platform is lowering. The platform stop at the height is approximately 3.0 m from the ground. The descent delay alarm will sound.

Note: Be sure the area below the platform is clear of personnel and obstructions before continuing.

- 12 Press and hold the lift function enable button. Press and hold the platform down button.
- ⊙ Result: The platform should lower to end. The descent delay alarm should sound while the platform is lowering.

### Test the Emergency Lowering

- 13 Activate the up function and raise the platform approximately 60 cm.
  - 14 Push in the red Emergency Stop button to the off position.
  - 15 Pull out the red Emergency Stop button to the on position.
  - 16 Press and hold the emergency lowering down enable button. Press and hold the emergency lowering down button.
- ⊙ Result: The platform should lower.
- 17 Turn the key switch to platform control.

## At the Platform Controls

### Test Emergency Stop

- 18 Push in the platform red Emergency Stop button to the off position.
- ⊙ Result: No functions should operate.
- 19 Pull the red Emergency Stop button out to the on position.

## Function Tests

- ⊙ Result: The LED indicator light should come on.

### Test the Horn

20 Push the horn button.

- ⊙ Result: The horn should sound.

### Test Up/Down Functions and Function Enable

21 Do not hold the function enable switch on the control handle.

22 Slowly move the control handle in the direction indicated by the blue arrow, then in the direction indicated by the yellow arrow.

- ⊙ Result: No functions should operate.

23 Press the lift function select button.

24 Press and hold the function enable switch on the control handle.

25 Slowly move the control handle in the direction indicated by the blue arrow.

- ⊙ Result: The platform should raise.

26 Release the control handle.

- ⊙ Result: The platform should stop raising.

27 Press and hold the function enable switch. Slowly move the control handle in the direction indicated by the yellow arrow.

- ⊙ Result: The platform should lower. The descent alarm should sound while the platform is lowering.

### Test the Steering

Note: When performing the steer and drive function test, stand in the platform facing the steer end of the machine.

28 Press the drive function select button. The indicator light should turn on.

29 Press and hold the function enable switch on the proportional control handle. Depress the thumb rocker switch on top of

the proportional control handle in the direction identified by the blue triangle on the control panel.

- ⊙ Result: The steer wheels should turn in the direction that the blue triangle points on the control panel.

30 Press and hold the function enable switch on the proportional control handle. Depress the thumb rocker switch in the direction identified by the yellow triangle on the control panel.

- ⊙ Result: The steer wheels should turn in the direction that the yellow triangle points on the control panel.

### Test Drive and Braking

31 Press and hold the function enable switch on the proportional control handle.

32 Slowly move the proportional control handle in the direction indicated by the blue arrow on the control panel until the machine begins to move, then return the proportional control handle to the center position.

- ⊙ Result: The machine should move in the direction that the blue arrow points on the control panel, then come to an abrupt stop.

33 Press and hold the function enable switch on the proportional control handle.

34 Slowly move the proportional control handle in the direction indicated by the yellow arrow on the control panel until the machine begins to move, then return the proportional handle to the center position.

- ⊙ Result: The machine should move in the direction that the yellow arrow points on the control panel, then come to an abrupt stop.

Note: The brakes must be able to hold the machine on any slope it is able to climb.

## Function Tests

### Test Limited Drive Speed

- 35 Press the lift function select button. Raise the platform approximately 3 m from the ground.
  - 36 Press the drive function select button.
  - 37 Press and hold the function enable switch on the proportional control handle slowly move the proportional control handle to the full drive position.
- ⊙ Result: The maximum achievable drive speed with the platform raised should not exceed 31cm/s.
  - ⊘ Result: If the drive speed with the platform raised exceeds 31cm/s, immediately tag and remove the machine from service.

### Test the Tilt Sensor Operation

Note: Perform this test from the ground with the platform controller. Do not stand in the platform.

- 38 Fully lower the platform.
  - 39 Drive both wheels on one side onto an 12cm block.
  - 40 Raise the platform approximately 3.0 m from the ground.
- ⊙ Result: The platform should stop and the tilt alarm will sound at 180 beeps per minute. The platform controls LED readout should display LL.
- 41 Press the drive function select button.
  - 42 Press and hold the function enable switch on the control handle.
  - 43 Move the proportional control handle in the direction indicated by the blue arrow, then move the proportional control handle in the direction indicated by the yellow arrow.
- ⊙ Result: The drive function should not work in either direction.
- 44 Press the lift function enable button.

- 45 Lower the platform and drive the machine off the block.

### Test the Up Limit Switch and the Outriggers (for JCPT1823DC)

Note: Perform this test from the ground with the platform controller. Do not stand in the platform.

- 46 Press and hold the function enable switch on the proportional control handle. Raise the platform.
- ⊙ Result: The platform should rise to 11 m and then stop. The platform should not rise above 11 m unless the outriggers are lowered.
- 47 Press the drive function select button. Drive the machine forward.
- ⊙ Result: The drive function should not operate.
- 48 Press the lift function select button.
  - 49 Lower the platform. If the platform is higher than 3 m from the ground, the outriggers will not lower.
  - 50 Lower the platform to the end.
  - 51 Push and hold the auto level button.
  - 52 Press and hold the function enable switch. Activate the proportional control handle in the direction indicated by the yellow arrow. The outriggers will extend and level the machine. A beep will sound when the machine is level.
  - 53 Raise the platform.
- ⊙ Result: The platform should rise to full height.
- 54 Lower the platform.

### Test Auxiliary Lowering

- 55 Push and hold the function enable switch and raise the platform approximately 60 cm.

## Function Tests

- 56 Push in the red Emergency Stop button
- 57 Pull out the red Emergency Stop button to the on position.
- 58 Push and hold the function enable switch. Activate the control handle in the direction indicated by the yellow arrow.

⊙ Result: The platform should lower.

### Test Outrigger Auxiliary Retract

- 59 Lower the platform to the lowest position.
- 60 Operator comes back to the ground, and operates the machine on the ground control.
- 61 Press and hold the lift function enable button. Press and hold the platform down button. Press and hold the overload indicator button

⊙ Result: The outrigger should retract.

### Test the Oscillate System

Note: Perform this test from the ground with the platform controller. Do not stand in the platform.

#### Test the Oscillate System (stowed position)

- 62 Drive the left steer tire up onto a 10 cm high ramp.
- ⊙ Result: All four tires should maintain firm contact with the ground.
- 63 Drive the right steer tire up onto a 10 cm high ramp.

⊙ Result: All four tires should maintain firm contact with the ground.

Note: Verify that there are no fault codes shown on ground control display.

#### Test the Oscillate System (elevated position)

- 64 Press the lift function select button. Raise the platform approximately 3.5 m from the ground.

- 65 Drive the left steer tire into a 10 cm deep hole.

⊙ Result: All four tires should maintain firm contact with the ground.

- 66 Drive the right steer tire into a 10 cm deep hole.

⊙ Result: All four tires should maintain firm contact with the ground.

Note: Verify that there are no fault codes shown on ground control display.



## Operating Instructions



### Do Not Operate Unless:

- You learn and practice the principles of safe machine operation contained in this operator's manual.
  - 1 Avoid hazardous situations.
  - 2 Always perform a pre-operation inspection.
  - 3 Inspect the workplace.
  - 4 Always perform function tests prior to use.
  - 5 Only use the machine as it was intended.**

### Fundamentals

This machine is a self-propelled hydraulic lift equipped with a work platform on the scissor mechanism. Vibrations emitted by these machines are not hazardous to an operator in the work platform. The machine can be used to position personnel with their tools and supplies at position above ground level and can be used to reach work areas located above and over machinery or equipment.

A full and detailed implementation of EN ISO 13849-1/2 is correctly applied on our MEWP design. SISTEMA, a software tool for PL Calculation Tool, is also used to perform some relatively straightforward calculations on subsystem to determine the overall PL of the system. Reliability data, diagnostic coverage [DC], the system architecture [Category], common cause failure and, where relevant, requirements for software are used to assess the PL to comply with PLr of SRP/CS in Clause 5.11 of EN 280.

The Operating Instructions section provides instructions for each aspect of machine operation.

It is the operator's responsibility to follow all the safety rules and instructions in the operator's manual.

Using the machine for anything other than lifting personnel, along with their tools and materials, to an aerial work site is unsafe and dangerous.

Only trained and authorized personnel should be permitted to operate a machine. If more than one operator is expected to use a machine at different times in the same work shift, they must all be qualified operators and are all expected to follow all safety rules and instructions in the operator's manual. That means every new operator should perform a pre-operation inspection, function tests, and a workplace inspection before using the machine.

## Operating Instructions

### Emergency Stop

Push in the red Emergency Stop button to the off position at the ground controls or the platform controls to stop all machine functions.

Repair any function that operates when either red Emergency Stop button is pushed in.

### Operation from Ground

- 1 Turn the key switch to ground control.
- 2 Turn the ground red Emergency Stop button clockwise to the on position
- 3 Pull out the platform red Emergency Stop button to the on position.

#### To Position Platform

- 1 Press the lift function enable button.
- 2 Press the platform up/down button to activate the up function or the down function.

Drive and steer functions are not available from the ground controls.

### Operation from Platform

- 1 Turn the key switch to platform control.
- 2 Turn the ground red Emergency Stop button clockwise to the on position
- 3 Pull out the platform red Emergency Stop button to the on position.

#### To Position Platform

- 1 Press the lift function select button.
- 2 Press and hold the function enable switch on the control handle.
- 3 Activate the proportional control handle in the desired direction.

#### To Steer

- 1 Press the drive function select button.

- 2 Press and hold the function enable switch on the control handle.
- 3 Turn the steer wheels with the thumb rocker switch located on the top of the control handle.

#### To Drive

- 1 Press the drive function select button.
- 2 Press and hold the function enable switch on the control handle.
- 3 Increase speed: Slowly move the control handle off center.

Decrease speed: Slowly move the control handle toward center.

Stop: Return the control handle to center or release the function enable switch.

Use the direction arrows on the platform controls to identify the direction the machine will travel.

Machine travel speed is restricted when the platform is raised.

#### Drive speed select

The drive controls can operate in two different drive speed modes. When the torque speed select button light is on, slow drive speed mode is active. When the High speed select button light is on, fast drive speed mode is active.

#### Driving on a slope

Determine the slope and side slope ratings for the machine and determine the slope grade.

##### JCPT1523DC

Maximum slope rating, stowed position 50%,  
Maximum side slope rating, stowed position 50%

##### JCPT1823DC

Maximum slope rating, stowed position 40%,  
Maximum side slope rating, stowed position 40%

## Operating Instructions

Note: Slope rating is subject to ground conditions and adequate traction.

Press the drive speed select switch to the fast drive speed mode.

### To determine the slope grade

Measure the slope with a digital inclinometer or use the following procedure.

You will need:

- Carpenter's level
- Straight piece of wood, at least 1 m long
- tape measure
- Lay the piece of wood on the slope

At the downhill end, lay the level on the top edge of the piece of wood and lift the end until the piece of wood is level.

While holding the piece of wood level, measure the distance from the bottom of the piece of wood to the ground.

Divide the tape measure distance (rise) by the length of the piece of wood (run) and multiply by 100.

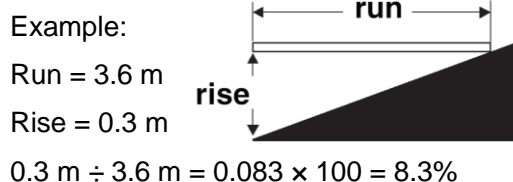

If the slope exceeds the maximum slope or side slope rating, the machine must be winched or transported up or down the slope. See Transport and Lifting section.

### To Extend and Retract Platform

- 1 Lift the platform extension lock handle to the horizontal position.
- 2 Push the platform extension lock handle to extend the platform to the desired position.  
Do not stand on the platform extension while trying to extend it.
- 3 Lower the platform extension lock handle.

### Battery Level Indicator

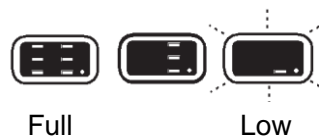

Use the LED diagnostic readout to determine the battery level.

### Auxiliary Lowering

#### At the Ground Controls

Press and hold the lift function enable button. Press and hold the platform down button.

#### At the Platform Controls

Press the lift function select button.

Push and hold the function enable switch. Activate the control handle in the direction indicated by the yellow arrow.

### Operation from Ground with Controller

Maintain safe distances between operator, machine and fixed objects.

Be aware of the direction the machine will travel when using the controller.

### Outrigger Operation (if equipped)

- 1 Position the machine below the desired work area.
- 2 Push and hold the outrigger auto level button.
- 3 Press and hold the function enable switch. Activate the proportional control handle in the direction indicated by the yellow arrow. The outriggers will extend and level the machine. A beep will sound when the machine is level.

## Operating Instructions

The indicator light on the lift function enable button will turn on when one but not all outriggers are down. All drive and lift functions are disabled.

The indicator lights on the lift function enable button and on the individual outrigger buttons will turn off when all the outriggers are in firm contact with the ground.

The drive function is disabled while the outriggers are down.

### To control individual outriggers

- 1 Push and hold one or more outrigger function enable buttons.
- 2 Press and hold the function enable switch. Activate the proportional control handle in the direction indicated by the yellow arrow. The outriggers will extend and level the machine.

**⚠ WARNING** Cannot use the outrigger directly on uneven surface, soft ground, pit edges and slopes greater ground, To avoid the risk of machine tipping, casualties and equipment damage. If it must be used on the above ground, be sure to use wood or steel pad adapt to the ground, and make sure it is firm.

### Outrigger Auxiliary Retract

- 1 The platform must be in the lowest height. Operation the machine on the ground control.
- 2 Press and hold the lift function enable button. Press and hold the platform down button. Press and hold the overload indicator button.

### How to use the Safety Arm

- 1 Raise the platform approximately 5.5 m from the ground.
- 2 Release the safety arm latch, lift the safety arm and rotate up to a vertical position. Lock the safety arm in position.

Note: Be sure that the safety arm is locked in the vertical position.

- 3 Lower the platform until the safety arm rests securely on the link.

**⚠ WARNING** Crushing hazard. Keep hand clear of the safety arm when lowering the platform.

**⚠ WARNING** Don't engage the safety arm unless unload the platform.

### After Each Use

- 1 Select a safe parking location - firm level surface, clear of obstructions and traffic.
- 2 Lower the platform.
- 3 Turn the key switch to the off position and remove the key to secure from unauthorized use.
- 4 Push in the red Emergency Stop buttons to "off" position.
- 5 Push in the main power switch to "off" position
- 6 Chock the wheels.

## Transport and Lifting Instructions



### Observe and Obey:

- ✓ Common sense and planning must be applied to control the movement of the machine when lifting it with a crane or forklift.
- ✓ The transport vehicle must be parked on a level surface.
- ✓ The transport vehicle must be secured to prevent rolling while the machine is being loaded.
- ✓ Be sure the vehicle capacity, loading surfaces and chains or straps are sufficient to withstand the machine weight. See the serial label for the machine weight.
- ✓ The machine must be on a level surface or secured before releasing the brakes.
- ✓ Do not drive the machine on a slope that exceeds the slope or side slope rating. See Driving on a Slope in the Operating Instructions section.
- ✓ If the slope of the transport vehicle bed exceeds the maximum slope rating, the machine must be loaded and unloaded using a winch as described.

### Free-wheel Configuration for Winching

Chock the wheels to prevent the machine from rolling.

2WD models: Release the non-steer wheel brakes by turning over the torque hub disconnect caps (see below).

4WD models: Release the wheel brakes by turning over all four torque hub disconnect caps (see below).

Be sure the winch line is properly secured to the drive chassis tie points and the path is clear of all obstructions.

Reverse the procedures described to re-engage the brakes.

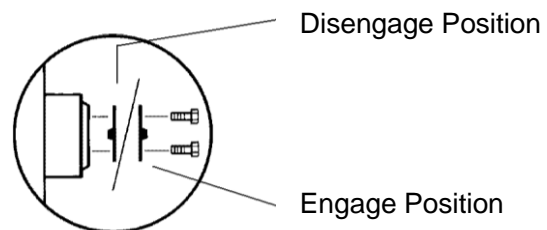

## Transport and Lifting Instructions

### Securing to Truck or Trailer for Transit

Always chock the machine wheels in preparation for transport.

Retract and secure the extension deck(s).

Use the tie-down points on the chassis for anchoring down to the transport surface.

Use a minimum of four chains or straps.

Use chains or straps of ample load capacity.

Turn the key switch to the off position and remove the key before transporting.

Inspect the entire machine for loose or unsecured items.

If the railings have been folded down, secure them with straps before transporting.

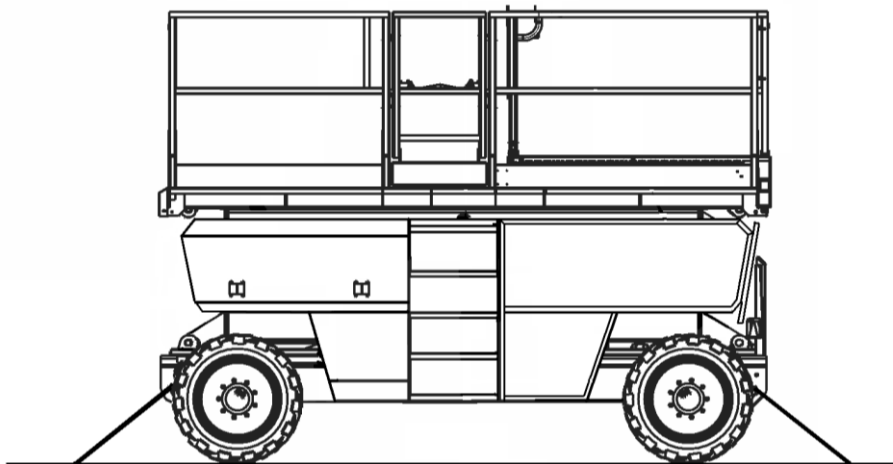
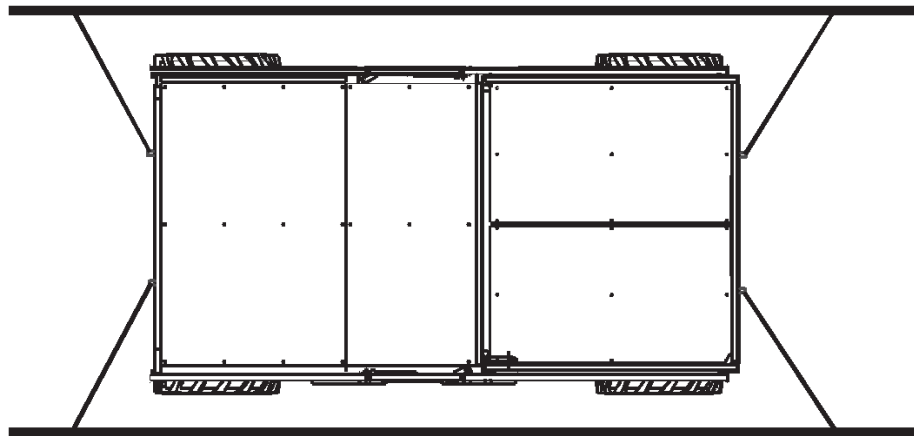

## Transport and Lifting Instructions



### Observe and Obey:

- Only qualified riggers should rig and lift the machine.
- Be sure the crane capacity, loading surfaces and straps or lines are sufficient to withstand the machine weight. See the serial plate for the machine weight.

Center of gravity	X Axis	Y Axis
JCPT1523DC without outriggers	1.95 m	1.0 m
JCPT1523DC with outriggers	2.00 m	1.0 m
JCPT1823DC	2.00 m	1.0 m

### Lifting Instructions

Fully lower the platform. Be sure the extension decks, controls and covers are secure. Remove all loose items on the machine.

Determine the center of gravity of your machine using the table and the picture on this page.

Attach the rigging only to the designated lifting points on the machine. There are two lifting points on each end of the machine.

Adjust the rigging to prevent damage to the machine and to keep the machine level.

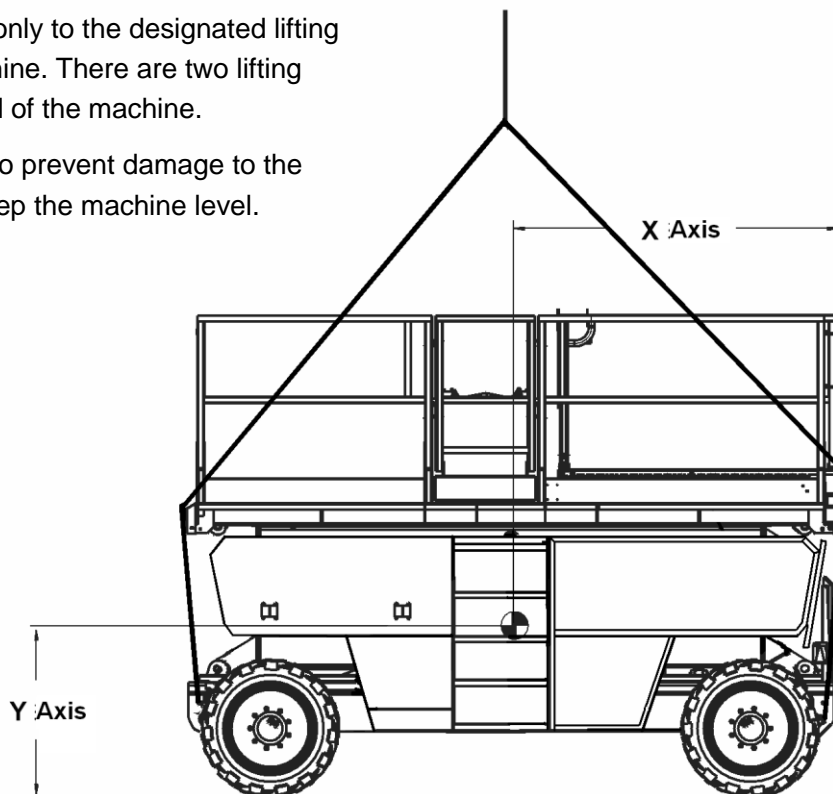

## Maintenance



### Observe and Obey:

- Only routine maintenance items specified in this manual shall be performed by the operator.
- Scheduled maintenance inspections shall be completed by qualified service technicians, according to the manufacturer's specifications and the requirements specified in this manual.

### Maintenance Symbols Legend

**NOTICE** The following symbols have been used in this manual to help communicate the intent of the instructions. When one or more of the symbols appear at the beginning of a maintenance procedure, it conveys the meaning below.



Indicates that tools will be required to perform this procedure.



Indicates that new parts will be required to perform this procedure.



Indicates that dealer service will be required to perform this procedure

### Pre-delivery Preparation Report

The pre-delivery preparation report contains checklists for each type of scheduled inspection.

Make copies of the Pre-delivery Preparation report to use for each inspection. Store completed forms as required.

### Maintenance Schedule

There are five types of maintenance inspections that must be performed according to a schedule— daily, quarterly, semi-annually, annually, and two year. The Scheduled Maintenance Procedures Section and the Maintenance Inspection Report have been divided into five subsections—A, B, C, D, and E. Use the following chart to determine which group(s) of procedures are required to perform a scheduled inspection.

Inspection	Checklist
Daily or every 8 hours	A
Quarterly or every 250 hours	A+B
Semi-annually or every 500 hours	A+B+C
Annually or every 1000 hours	A+B+C+D
Two year or every 2000 hours	A+B+C+D+E

### Maintenance Inspection Report

The maintenance inspection report contains checklists for each type of scheduled inspection.

Make copies of the Maintenance Inspection Report to use for each inspection. Maintain completed forms for a minimum of 4 years or in compliance with your employer, jobsite and governmental regulations and requirements.



# Maintenance

## Pre-delivery Preparation Report

### Fundamentals

It is the responsibility of the dealer to perform the Pre-delivery Preparation.

The Pre-delivery Preparation is performed prior to each delivery. The inspection is designed to discover if anything is apparently wrong with a machine before it is put into service.

A damaged or modified machine must never be used. If damage or any variation from factory delivered condition is discovered, the machine must be tagged and removed from service.

Repairs to the machine may only be made by a qualified service technician, according to the manufacturer's specifications.

Scheduled maintenance inspections shall be performed by qualified service technicians, according to the manufacturer's specifications and the requirements listed in this manual.

### Instructions

Use the operator's manual on your machine.

The Pre-delivery Preparation consists of completing the Pre-operation Inspection, the Maintenance items and the Function Tests.

Use this form to record the results. Place a check in the appropriate box after each part is completed. Follow the instructions in the operator's manual.

If any inspection receives an N, remove the machine from service, repair and re-inspect it. After repair, place a check in the R box.

### Legend

Y = yes, completed

N = no, unable to complete

R = repaired

### Comments

Pre-Delivery Preparation	Y	N	R
Pre-operation inspection completed			
Maintenance items completed			
Function tests completed			

Model

Serial number

Date

Machine owner

Inspected by (print)

Inspector signature

Inspector title

Inspector company

## Maintenance

### Maintenance Inspection Report

<b>Model</b>
<b>Serial number</b>
<b>Date</b>
<b>Hour meter</b>
<b>Machine owner</b>
<b>Inspected by (print)</b>
<b>Inspector signature</b>
<b>Inspector title</b>
<b>Inspector company</b>
<b>Instructions</b>
<ul style="list-style-type: none"> <li>• Make copies of this report to use for each inspection.</li> <li>• Select the appropriate checklist(s) for the type of inspection to be performed.</li> </ul>
<input type="checkbox"/> Daily or 8 hours Inspection: <span style="float: right;">A</span>
<input type="checkbox"/> Quarterly or 250 hours Inspection: <span style="float: right;">A+B</span>
<input type="checkbox"/> Semi-annually or 500 hours Inspection: <span style="float: right;">A+B+C</span>
<input type="checkbox"/> Annually or 1000 hours Inspection: <span style="float: right;">A+B+C+D</span>
<input type="checkbox"/> Two year or 2000 hours Inspection: <span style="float: right;">A+B+C+D+E</span>
<ul style="list-style-type: none"> <li>• Place a check in the appropriate box after each inspection procedure is completed.</li> <li>• Use the step-by-step procedures in this section to learn how to perform these inspections.</li> <li>• If any inspection receives an "N", tag and remove the machine from service, repair and re-inspect it. After repair, place a check in the "R" box.</li> </ul>
<b>Legend</b>
Y = yes, acceptable
N = no, remove from service
R = repaired

<b>Checklist A</b>	<b>Y</b>	<b>N</b>	<b>R</b>
A-1 Inspect the manuals and decals			
A-2 Pre-operation inspection			
A-3 Check the Batteries			
A-4 Check the Hydraulic Oil Level			
A-5 Function tests			
<b>Perform after 40 hours:</b>			
A-6 30 day service			
<b>Checklist B</b>	<b>Y</b>	<b>N</b>	<b>R</b>
B-1 Batteries			
B-2 Electrical wiring			
B-3 Confirm the Proper Brake Configuration			
B-4 Tires and wheels			
B-5 Check the Oil Level in the Drive Hubs			
B-6 Key switch			
B-7 Emergency stop			
B-8 Horn (if equipped)			
B-9 Drive brakes			
B-10 Drive speed - stowed			
B-11 Drive speed - raised			
<b>Checklist C</b>	<b>Y</b>	<b>N</b>	<b>R</b>
C-1 Platform overload (if equipped)			
<b>Checklist D</b>	<b>Y</b>	<b>N</b>	<b>R</b>
D-1 Return filter element			
D-2 Free-wheel configuration			
D-3 Replace the Drive Hub Oil			
<b>Checklist E</b>	<b>Y</b>	<b>N</b>	<b>R</b>
E-1 Hydraulic oil			

## Maintenance

### Checklist A Procedures

#### A-1

#### Inspect the Manuals and Decals

Maintaining the operator's manual in good condition is essential to safe machine operation. Manuals are included with each machine and should be stored in the container provided in the platform. An illegible or missing manual will not provide safety and operational information necessary for a safe operating condition.

In addition, maintaining all of the safety and instructional decals in good condition is mandatory for safe machine operation. Decals alert operators and personnel to the many possible hazards associated with using this machine. They also provide users with operation and maintenance information. An illegible decal will fail to alert personnel of a procedure or hazard and could result in unsafe operating conditions.

- 1 Check to make sure that the operator's manual is present and complete in the storage container on the platform.
- 2 Examine the pages of manual to be sure that they are legible and in good condition.

☉ Result: The operator's manual is appropriate for the machine and the manual are legible and in good condition.

☒ Result: The operator's manual is not appropriate for the machine or the manual is not in good condition or is illegible. Remove the machine from service until the manual is replaced.

- 3 Open the operator's manual to the decals inspection section. Carefully and thoroughly inspect all decals on the machine for legibility and damage.

☉ Result: The machine is equipped with all required decals, and all decals are legible and in good condition.

☒ Result: The machine is not equipped with all required decals, or one or more decals are illegible or in poor condition. Remove the machine from service until the decals are replaced.

- 4 Always return the manual to the storage container after use.

Note: Contact your authorized DINGLI distributor or DINGLI Industries if replacement manuals or decals are needed.

**A-2****Perform Pre-operation Inspection**

Completing a Pre-operation Inspection is essential to safe machine operation. The Pre-operation Inspection is a visual inspection performed by the operator prior to each work shift. The inspection is designed to discover if anything is apparently wrong with a machine before the operator performs the function tests. The Pre-operation Inspection also serves to determine if routine maintenance procedures are required.

Complete information to perform this procedure is available in the appropriate operator's manual. Refer to the Operator's Manual on your machine.

**A-3****Check the Batteries**

Proper battery condition is essential to good machine performance and operational safety. Improper fluid levels or damaged cables and connections can result in component damage and hazardous conditions.

**⚠ WARNING** Electrocution hazard.

Contact with hot or live circuits may result in death or serious injury. Remove all rings, watches and other jewelry.

**⚠ WARNING** Bodily injury hazard.

Batteries contain acid. Avoid spilling or contacting battery acid. Neutralize battery acid spills with baking soda and water.

- 1 Put on protective clothing and eye wear.
- 2 Be sure that the battery cable connections are tight and free of corrosion.
- 3 Be sure that the battery hold-down bars are secure.
- 4 Remove the battery vent caps.
- 5 Check the battery acid level. If needed, replenish with distilled water to the bottom of the battery fill tube. Do not overfill.
- 6 Install the vent caps.

## Maintenance

### A-4

#### Check the Hydraulic Oil Level



Maintaining the hydraulic oil at the proper level is essential to machine operation. Improper hydraulic oil levels can damage hydraulic components. Daily checks allow the inspector to identify changes in oil level that might indicate the presence of hydraulic system problems.

#### **NOTICE**

Perform this procedure with the platform in the stowed position

- 1 Visually inspect the sight of hydraulic oil level from the side of the hydraulic oil tank.

⊙ Result: The hydraulic oil level should be within the top 5 cm of the tank.

- 2 Add oil if necessary. Do not overfill.

#### **NOTICE**

**Original Hydraulic oil specifications: L-HV46**

Customers shall choose the appropriate hydraulic oil according to the ambient temperature used.

Example: L-HV32 or L-HV68

### A-5

#### Perform Function Tests

Completing the function tests is essential to safe machine operation. Function tests are designed to discover any malfunctions before the machine is put into service. A malfunctioning machine must never be used. If malfunctions are discovered, the machine must be tagged and removed from service.

Complete information to perform this procedure is available in the appropriate operator's manual. Refer to the Operator's Manual on your machine.

### A-6

#### Perform 30 Day Service



The 30 day maintenance procedure is a one time procedure to be performed after the first 30 days or 40 hours of usage. After this interval, refer to the maintenance tables for continued scheduled maintenance.

- 1 Perform the following maintenance procedures:
  - B-3 Inspect the Tires and Wheels (including lug nut torque)

## Checklist B Procedures

### B-1

#### Inspect the Batteries



DINGLI requires that this procedure be performed every 250 hours or quarterly, whichever comes first.

Proper battery condition is essential to good machine performance and operational safety. Improper fluid levels or damaged cables and connections can result in component damage and hazardous conditions.

**⚠ WARNING** Electrocutation / burn hazard. Contact with electrically charged circuits could result in death or serious injury. Remove all rings, watches and other jewelry.

**⚠ WARNING** Bodily injury hazard. Batteries contain acid. Avoid spilling or contacting battery acid. Neutralize battery acid spills with baking soda and water.

- 1 Put on protective clothing and eye wear.
- 2 Be sure that the battery cable connections are free of corrosion.

Note: Adding terminal protectors and a corrosion preventative sealant will help eliminate corrosion on the battery terminals and cables.

- 3 Be sure that the battery retainers and cable connections are tight.
- 4 Fully charge the battery. Allow the battery to rest 24 hours before performing this procedure to allow the battery cells to equalize.

#### **Models without maintenance-free or sealed batteries:**

- 5 Remove the battery vent caps and check the specific gravity of each battery cell with a hydrometer. Note the results.

- 6 Check the ambient air temperature and adjust the specific gravity reading for each cell as follows:

- Add 0.004 to the reading of each cell for every 5.5° C above 26.7° C.
- Subtract 0.004 from the reading of each cell for every 5.5° C below 26.7° C.

- ⊙ Result: All battery cells display an adjusted specific gravity of 1.277 or higher. The battery is fully charged. Proceed to step 10.

- ⊘ Result: One or more battery cells display a specific gravity of 1.217 or below. Proceed to step 7.

- 7 Perform an equalizing charge OR fully charge the batteries and allow the battery to rest at least 6 hours.

- 8 Remove the battery vent caps and check the specific gravity of each battery cell with a hydrometer. Note the results.

- 9 Check the ambient air temperature and adjust the specific gravity reading for each cell as follows:

- Add 0.004 to the reading of each cell for every 5.5° C above 26.7° C.
- Subtract 0.004 from the reading of each cell for every 5.5° C below 26.7° C.

- ⊙ Result: All battery cells display a specific gravity of 1.277 or greater. The battery is fully charged. Proceed to step 10.

- ⊘ Result: The difference in specific gravity readings between cells is greater than 0.1 OR the specific gravity of one or more cells is less than 1.217. Replace the battery.

## Maintenance

- 10 Check the battery acid level. If needed, replenish with distilled water to 1/8 inch | 3 mm below the bottom of the battery fill tube. Do not overfill.
- 11 Install the vent caps and neutralize any electrolyte that may have spilled.

### B-2

#### Inspect the Electrical Wiring



DINGLI requires that this procedure be performed every 250 hours or quarterly, whichever comes first.

Maintaining electrical wiring in good condition is essential to safe operation and good machine performance. Failure to find and replace burnt, chafed, corroded or pinched wires could result in unsafe operating conditions and may cause component damage.

**⚠ WARNING** Electrocutation / burn hazard. Contact with electrically charged circuits could result in death or serious injury. Remove all rings, watches and other jewelry.

- 1 Inspect the underside of the chassis for damaged or missing ground strap(s).
- 2 Inspect the following areas for burnt, chafed, corroded and loose wires:
  - Ground control panel
  - Hydraulic power unit module tray
  - Battery pack module tray
  - Platform controls
- 3 Inspect for a liberal coating of dielectric grease in the following locations:
  - Between the ECM and platform controls
  - All wire harness connectors
  - Level sensor
- 4 Turn the key switch to ground control. Pull out the platform and ground red Emergency Stop button to the on position.
- 5 Raise the platform approximately 5.5m from the ground.
- 6 Use the Safety Arm. Stop the machine.

**⚠ WARNING** Crushing hazard. Keep hands clear of the safety arm when lowering the platform.

- 7 Inspect the center chassis area and scissor arms for burnt, chafed and pinched cables.
- 8 Inspect the following areas for burnt, chafed, corroded, pinched and loose wires:
  - Scissor arms
  - ECM to platform controls
  - Power to platform wiring
- 9 Inspect for a liberal coating of dielectric grease in all connections between the ECM and the platform controls.
- 10 Raise the platform and return the safety arm to the stowed position.
- 11 Lower the platform to the stowed position and turn the machine off.

**B-3****Confirm the Proper Brake Configuration**

Dingli requires that this procedure be performed every 250 hours or quarterly, whichever comes

Proper brake configuration is essential to safe operation and good machine performance. Hydraulically-released, spring-applied individual wheel brakes can appear to operate normally when they are actually not fully operational.

Check each drive hub disconnect cap to be sure it is in the engaged position.

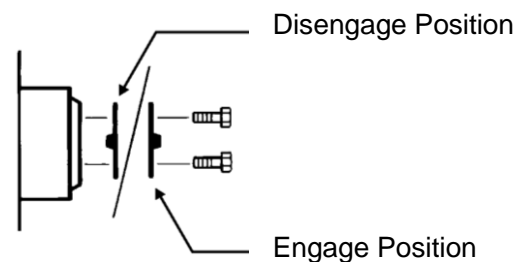



## Maintenance

### B-4

#### Inspect the Tires and Wheels



Dingli requires that this procedure be performed every 250 hours or quarterly, whichever comes

Maintaining the tires and wheels in good condition is essential to safe operation and good performance. Tire and/or wheel failure could result in a machine tip-over. Component damage may also result if problems are not discovered and repaired in a timely fashion.

- 1 Check all tire treads and sidewalls for cuts, cracks, punctures and unusual wear.
- 2 Check each wheel for damage, bends and cracks.
- 3 Check each lug nut for proper torque.

lug nut torque, dry	169.5Nm
---------------------	---------

lug nut torque, lubricated	127.4Nm
----------------------------	---------

### B-5

#### Check the Oil Level in the Drive Hubs



Dingli requires that this procedure be performed every 250 hours or quarterly, whichever comes

Failure to maintain proper drive hub oil levels may cause the machine to perform poorly and continued use may cause component damage.

- 1 Drive the machine to rotate the hub until the plugs are located one on top and the other at 90 degrees.

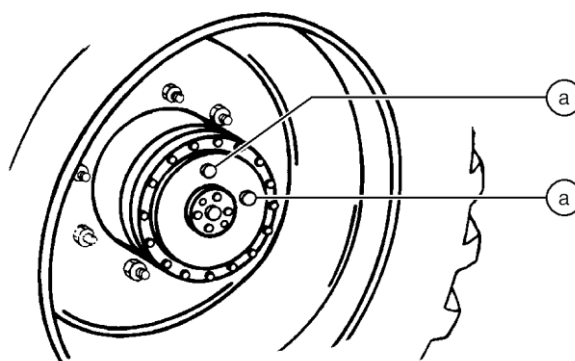

a drive hub plugs

- 2 Remove the plug located at 90 degrees and check the oil level.
  - ⊙ Result: The oil level should be even with the bottom of the side plug hole.
- 3 If necessary, remove the top plug and add oil until the oil level is even with the bottom of the side plug hole.
- 4 Apply pipe thread sealant to the plug(s), and then install the plug(s) in the drive hub.
- 5 Repeat this procedure for each drive hub.

#### NOTICE

**Original oil specifications:**

**80W-90**

## Maintenance

### B-6

#### Test the Key Switch

Dingli requires that this procedure be performed every 250 hours or quarterly, whichever comes first.

Proper key switch action and response is essential to safe machine operation. Failure of the key switch to activate the appropriate control panel could cause a hazardous operating situation.

- 1 Pull out the platform and ground red Emergency Stop button to the on position.
- 2 Turn the key switch to ground controls.
- 3 Check any machine function from the platform controls.
- ⊙ Result: The machine functions should not operate.
- 4 Turn the key switch to platform controls.
- 5 Check any machine function from the ground controls.
- ⊙ Result: The machine functions should not operate.
- 6 Turn the key switch to the off position.
- ⊙ Result: No machine functions should operate.

### B-7

#### Test the Emergency Stop

Dingli requires that this procedure be performed every 250 hours or quarterly, whichever comes first.

A properly functioning Emergency Stop is essential for safe machine operation. An improperly operating red Emergency Stop button will fail to shut off power and stop all machine functions, resulting in a hazardous situation.

As a safety feature, selecting and operating the ground controls will override the platform controls, except the platform red Emergency Stop button.

- 1 Turn the key switch to ground control. Pull out the platform and ground red Emergency Stop button to the on position.
- 2 Push in the red Emergency Stop button at the ground controls to the off position.
- ⊙ Result: No machine functions should operate.
- 3 Turn the key switch to platform control. Pull out the platform and ground red Emergency Stop button to the on position.
- 4 Push down the red Emergency Stop button at the platform controls to the off position.
- ⊙ Result: No machine functions should operate.

Note: The red Emergency Stop button at the ground controls will stop all machine operation, even if the key switch is switched to platform control.

## Maintenance

### B-8

#### Test the Automotive-style Horn

Dingli requires that this procedure be performed every 250 hours or quarterly, whichever comes first.

A functional horn is essential to safe machine operation. The horn is activated at the platform controls and sounds at the ground as a warning to ground personnel. An improperly functioning horn will prevent the operator from alerting ground personnel of hazards or unsafe conditions.

- 1 Turn the key switch to platform control. Pull out the platform and ground red Emergency Stop button to the on position.
- 2 Push down the horn button at the platform controls.

⊙ Result: The horn should sound.

Note: If necessary, the horn can be adjusted to obtain the loudest volume by turning the adjustment screw near the wire terminals on the horn.

### B-9

#### Test the Drive Brakes



Dingli requires that this procedure be performed every 250 hours or quarterly, whichever comes first.

Proper brake action is essential to safe machine operation. The drive brake function should operate smoothly, free of hesitation, jerking and unusual noise.

Hydraulically-released individual wheel brakes can appear to operate normally when they are actually not fully operational.

- 1 Mark a test line on the ground for reference.
- 2 Turn the key switch to platform control. Pull out the platform and ground red Emergency Stop button to the on position.
- 3 Lower the platform to the stowed position.
- 4 Press the drive function select button.
- 5 Choose a point on the machine; i.e., contact patch of a tire, as a visual reference for use when crossing the test line.
- 6 Bring the machine to top drive speed before reaching the test line. Release the function enable switch or the joystick when your reference point on the machine crosses the test line.
- 7 Measure the distance between the test line and your machine reference point.

⊙ Result: The machine stops within the specified braking distance. No action required.

⊘ Result: The machine does not stop within the specified braking distance.

**Maintenance**

Note: The brakes must be able to hold the machine on any slope it is able to climb.

- 8 Replace the brakes and repeat this procedure beginning with step 1.

**Braking distance, maximum**

High range on paved surface	<150cm
-----------------------------	--------

**B-10****Test the Drive Speed - Stowed Position**

Dingli requires that this procedure be performed every 250 hours or quarterly, whichever comes

Proper drive function movement is essential to safe machine operation. The drive function should respond quickly and smoothly to operator control. Drive performance should also be free of hesitation, jerking and unusual noise over the entire proportionally control led speed range.

- 1 Create start and finish lines by marking two lines on the ground 12.2m apart.
- 2 Turn the key switch to platform controls
- 3 Pull out the platform and ground red Emergency Stop button to the on position.
- 4 Lower the platform to the stowed position.
- 5 Choose a point on the machine; i.e., contact patch of a tire, as a visual reference for use when crossing the start and finish lines.
- 6 Bring the machine to maximum drive speed before reaching the start line. Begin timing when your reference point on the machine crosses the start line.
- 7 Continue at full speed and note the time when the machine reference point passes over the finish line. The time is less than 7.2sec.

## Maintenance

### B-11

#### Test the Drive Speed -Raised Position



Dingli requires that this procedure be performed every 250 hours or quarterly, whichever comes first.

Proper drive function movement is essential to safe machine operation. The drive function should respond quickly and smoothly to operator control. Drive performance should also be free of hesitation, jerking and unusual noise over the entire proportionally control led speed range.

- 1 Create start and finish lines by marking two lines on the ground 12.2m apart.
- 2 Turn the key switch to platform controls
- 3 Pull out the platform and ground red Emergency Stop button to the on position.
- 4 Press and hold the function enable button. Raise the platform approximately 4.0m from the ground.
- 5 Choose a point on the machine; i.e., contact patch of a tire, as a visual reference for use when crossing the start and finish lines.
- 6 Bring the machine to maximum drive speed before reaching the start line. Begin timing when your reference point on the machine crosses the start line.
- 7 Continue at full speed and note the time when the machine reference point passes over the finish line. The time is less than 40 sec.

## Checklist C Procedures

### C-1

#### Test the Platform Overload System



Dingli specifications require that this procedure be performed every 500 hours or semi-annually, whichever comes first OR when the machine fails to lift the maximum rated load.

Testing the platform overload system regularly is essential to safe machine operation. Continued use of an improperly operating platform overload system could result in the system not sensing an overloaded platform condition. Machine stability could be compromised resulting in the machine tipping over.

Note: Perform this procedure with the machine on a firm, level surface that is free of obstructions.

- 1 Turn the key switch to platform controls. Pull out the platform and ground red Emergency Stop button to the on position.
- 2 Determine the maximum platform capacity.
- 3 Using a suitable lifting device, place an appropriate test weight equal to the maximum platform capacity in the center of the platform floor. Raise the platform.
  - ⊙ Result: The overload alarm not sounds during the whole trip, indicating a normal condition.
  - ⊗ Result: The overload alarm sounds during the whole trip. Calibrate the platform overload system.
- 4 The platform should lower to the stowed position.

- 5 Add an additional weight to the platform not to exceed 20% of the maximum rated Load. Raise the platform.
  - ⊙ Result: The overload alarm at the platform controls sound, indicating a normal condition.
  - ⊗ Result: The overload alarm at the platform controls does not sound. Calibrate the platform overload system.
- 6 Test all machine functions from the platform controls.
  - ⊙ Result: All platform control functions should not operate.
- 7 Turn the key switch to ground control.
- 8 Test all machine functions from the ground controls.
  - ⊙ Result: All ground control functions should not operate.
- 9 Lift the test weight off the platform floor using a suitable lifting device.
- 10 The platform should lower to the stowed position.

## Maintenance

### Checklist D Procedures

#### D-1

##### Check the Scissor Arm Wear Pads



Dingli specifications require that this procedure be performed every 1000 hours or annually, whichever comes first.

Maintaining the scissor arm wear pads in good condition is essential to safe machine operation. Continued use of worn out wear pads may result in component damage and unsafe operating conditions.

- 1 Measure the thickness of each chassis wear pad at the steer end of the machine.
  - ⊙ Result: The measurement is 8 mm or more. Proceed to step 2.
  - ⊗ Result: The measurement is less than 8mm. Replace both wear pads.
- 2 Measure the thickness of each chassis wear pad at the non-steer end of the machine.
  - ⊙ Result: The measurement is 8mm or more. Proceed to step 3.
  - ⊗ Result: The measurement is less than 8mm. Replace both wear pads.
- 3 Measure the thickness of each platform scissor arm wear pad at the steer end of the machine.
  - ⊙ Result: The measurement is 8 mm or more. Proceed to step 4.
  - ⊗ Result: The measurement is less than 8 mm. Replace both wear pads.
- 4 Measure the thickness of each platform scissor arm wear pad at the non-steer end of the machine.
  - ⊙ Result: The measurement is 8 mm or more.
  - ⊗ Result: The measurement is less than 5 /16 inch / 8 mm. Replace both wear pads.

#### D-2

##### Check the Free-wheel Configuration



Dingli specifications require that this procedure be performed every 1000 hours or annually, whichever comes first.

Proper use of the free-wheel configuration is essential to safe machine operation. The free-wheel configuration is used primarily for towing. A machine configured to free-wheel without operator knowledge may cause death or serious injury and property damage.

**⚠ WARNING** Collision hazard. Select a work site that is firm and level.

**NOTICE** Component damage hazard. If the machine must be towed, do not exceed 6.1km/h.

- 1 Chock the wheels at the steer end of the machine.
- 2 Center a lifting jack of ample capacity (20,000 lbs / 10,000 kg) under the drive chassis between the wheels at the non-steer end of the machine.
- 3 Lift the wheels off the ground and place blocks under the drive chassis for support.

**⚠ WARNING** Crushing hazard. The chassis could fall if not properly supported.

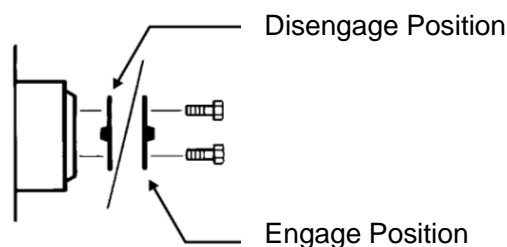

- 4 Disengage the drive hubs by turning over the drive hub disconnect caps on each wheel hub at the non-steer end.

**Maintenance**

- 5 Manually rotate each wheel at the non-steer end.
- ⊙ Result: Each wheel should rotate with minimum effort.
- 6 Engage the drive hubs by turning over the hub disconnect caps. Rotate each wheel to check for engagement. Raise the machine and remove the blocks. Lower the machine.

**⚠ WARNING** Collision hazard. Failure to engage the drive hubs could result in death or serious injury and property damage.

- 7 Chock the wheels at the non-steer end of the machine.
- 8 Center a lifting jack of ample capacity (20,000 lbs / 10,000 kg) under the drive chassis between the wheels at the steer end.
- 9 Lift the wheels off the ground and place blocks under the drive chassis for support.

**⚠ WARNING** Crushing hazard. The chassis could fall if not properly supported.

- 10 Disengage the drive hubs by turning over the drive hub disconnect caps on each wheel hub at the steer end.
- 11 Manually rotate each wheel at the steer end.
- ⊙ Result: Each wheel should rotate with minimum effort.
- 12 Engage the drive hubs by turning over the hub disconnect caps. Rotate each wheel to check for engagement. Raise the machine and remove the blocks. Lower the machine.

**⚠ WARNING** Collision hazard. Failure to engage the drive hubs could result in death or serious injury and property damage.

**D-3****Replace the Drive Hub Oil**

Dingli specifications require that this procedure be performed every 1000 hours or annually, whichever comes first.

Replacing the drive hub oil is essential for good machine performance and service life. Failure to replace the drive hub oil at yearly intervals may cause the machine to perform poorly and continued use may cause component damage.

- 1 Select the drive hub to be serviced. Drive the machine until one of the two plugs is at the lowest point.
- 2 Remove both plugs and drain the oil into a suitable container.
- 3 Drive the machine until one plug is at the top.

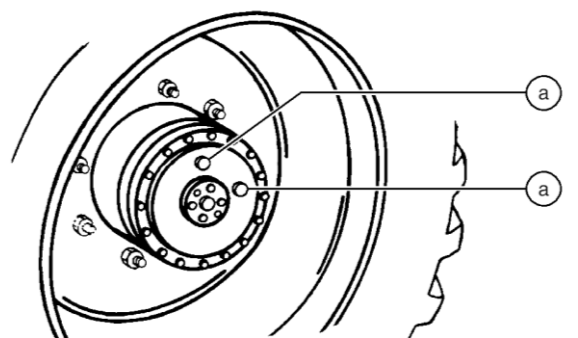

a drive hub plugs

- 4 Fill the hub with oil from the top hole until the oil level is even with the bottom of the side hole. Apply pipe thread sealant to the plugs. Install the plugs.
- 5 Repeat steps 1 through 4 for all the other drive hubs.

**NOTICE**

**Original oil specifications:**

**80W-90**



## Maintenance

### Checklist E Procedures

#### E-1

#### Test or Replace the Hydraulic Oil



DINGLI requires that this procedure be performed every 2000 hours or every two years, whichever comes first.

Replacement or testing of the hydraulic oil is essential for good machine performance and service life. Dirty oil and suction strainers may cause the machine to perform poorly and continued use may cause component damage. Extremely dirty conditions may require oil changes to be performed more frequently.

#### NOTICE

Component damage hazard.

The work area and surfaces where this procedure will be performed must be clean and free of debris that could get into the hydraulic system.

Before replacing the hydraulic oil, the oil may be tested by an oil distributor for specific levels of contamination to verify that changing the oil is necessary.

If the hydraulic oil is not replaced at the two year inspection, test the oil quarterly. Replace the oil when it fails the test.

Note: Perform this procedure with the platform in the stowed position.

#### ⚠ WARNING

Electrocution / burn hazard: Contact with electrically charged circuits could result in death or serious injury. Remove all rings, watches and other jewelry.

#### ⚠ WARNING

Bodily injury hazard. Spraying hydraulic oil can penetrate and burn skin. Loosen hydraulic connections very slowly to allow the oil pressure to dissipate gradually. Do not allow oil to squirt or spray.

- 1 Disconnect the battery pack from the machine.
- 2 Open the power unit module cover.
- 3 Remove the oil drain plug at bottom Drain all of the oil into a suitable container.
- 4 Tag and disconnect the hydraulic tank return line from the hydraulic filter head and remove the line from the tank. Cap the fitting on the filter head.
- 5 Tag and disconnect the hydraulic pump inlet line and remove the line from the tank. Cap the fitting on the pump.
- 6 Remove the hydraulic tank retaining fasteners and remove the hydraulic tank from the machine.
- 7 Open the tank cover and remove the oil filter.
- 8 Remove the breather cap from the hydraulic tank.
- 9 Clean the inside of the hydraulic tank using a mild solvent. Allow the tank to dry completely.
- 10 Tighten the drain plug.
- 11 Install a new oil filter onto the tank and install the tank cover.
- 12 Install the breather cap onto the hydraulic tank.
- 13 Install the hydraulic tank and install and tighten the hydraulic tank retaining fasteners.
- 14 Install the hydraulic pump inlet line into the tank. Install the fitting onto the pump and torque.

## Maintenance

- 15 Install the hydraulic pump return line into the tank. Install the fitting onto the hydraulic filter head and torque.
- 16 Add the tank with hydraulic oil until the fluid is equal in the hydraulic tank.

**⚠ WARNING** Component damage hazard.  
The pump can be damaged if operated without oil. Be careful not to empty the hydraulic tank while in the process of filling the hydraulic system. Do not allow the pump to cavitate.

## Maintenance

### Fault State

In the fault state, a fault code from the list will be displayed flashing at a 1 Hz rate (0.5 seconds on, 0.5 off).

#### List of Fault Codes

Display for Platform	Display for Ground	Description	Description
01	System fault	Main ECU System Fault	Replace Main ECU
02	Communication fault	ECU/Platform Communication Fault	Check the wiring, check the platform/ground control
08	Left float valve fault	Left float valve fault	check the wiring, replace the valve.
09	Right float valve fault	Right float valve fault	check the wiring, replace the valve.
14	Angle Sensor Fault	Angle Sensor Fault	check the wiring, replace the sensor.
15	Pressure Sensor Fault	Pressure Sensor Fault	check the wiring, replace the sensor.
20	Chassis start button fault	Chassis Start Switch ON at power-up	Check the switch, check the wiring
21	Chassis Choke button Fault	Chassis Choke Switch ON at power-up	Check the switch, check the wiring
22	Chassis Up button Fault	Chassis Up Switch ON at power-up	Check the switch, check the wiring
23	Chassis enable button Fault	Chassis Lift Switch ON at power-up	Check the switch, check the wiring
24	Chassis Down button Fault	Chassis Down Switch ON at power-up	Check the switch, check the wiring
25	PCU steer left button fault	Platform Left Turn Switch ON at power-up	Check the switch, replace the platform
26	PCU steer right button fault	Platform Right Turn Switch ON at power-up	Check the switch, replace the platform
27	PCU enable button fault	Platform Drive Enable Switch ON at power-up	Check the switch, replace the platform
28	PCU joystick out of neutral fault	Platform Joystick not in neutral ON at power-up	Check the switch, replace the platform
31	PCU choke button fault	Platform Choke Switch ON at power-up	Check the switch, replace the platform
32	PCU start button fault	Platform Start Switch ON at power-up	Check the switch, replace the platform

**Maintenance**

<b>Display for Platform</b>	<b>Display for Ground</b>	<b>Description</b>	<b>Repair</b>
33	PCU LF outrigger button fault	Platform Left Front Outrigger Enable Switch ON at power-up	Check the switch, replace the platform
34	PCU RF outrigger button fault	Platform Right Front Outrigger Enable Switch ON at power-up	Check the switch, replace the platform
35	PCU LR outrigger button fault	Platform Left Rear Outrigger Enable Switch ON at power-up	Check the switch, replace the platform
36	PCU RR outrigger button fault	Platform Right Rear Outrigger Enable Switch ON at power-up	Check the switch, replace the platform
37	PCU auto outrigger button fault	Platform Outrigger Auto Level Enable Switch ON at power-up	Check the switch, replace the platform
41	High Limit Switch Fault	High Limit Switch Fault	Check the switch, check the wiring
42	9m limit switch fault	9M Limit Switch Fault	Check the switch, check the wiring
43	Outrigger not extended	Outrigger Not Extended Fault	Extend Outrigger or lift down the platform.
44	Float limit switch fault	Float Limit Switch Fault	Check the switch, check the wiring
45	Float En valve Fault	Float Enable valve Fault	check the wiring, replace the valve
46	Float Unload valve Fault	Float Unload valve Fault	check the wiring, replace the valve
47	Float Lock valve Fault	Float Lock valve Fault	check the wiring, replace the valve
48	Left float valve fault	Left float valve fault	check the wiring, replace the valve
49	Right float valve fault	Right float valve fault	check the wiring, replace the valve
53	Proportional valve fault	Proportional valve fault	check the wiring, replace the valve
54	UP valve fault	Power FET, channel DOWN fails	check the wiring, replace the valve
55	Down valve fault	Power FET, channel RT fails	check the wiring, replace the valve
56	Steer right valve fault	Power FET, channel LT fails	check the wiring, replace the valve
57	Steer left valve fault	Power FET, channel LT fails	check the wiring, replace the valve
58	Brake valve fault	Brake valve fault	check the wiring, replace the valve

## Maintenance

Display for Platform	Display for Ground	Description	Repair
68	Battery low voltage fault	Low Battery Voltage	check the wiring, check the battery
75	LF MC fault	Left Front Motor controller Alarm	check the wiring, replace the controller
76	LR MC fault	Left Rear Motor controller Alarm	check the wiring, replace the controller
77	RF MC fault	Right Front Motor controller Alarm	check the wiring, replace the controller
78	RR MC fault	Right Rear Motor controller Alarm	check the wiring, replace the controller
81	LF outrigger valve fault	LF outrigger valve fault	check the wiring, replace the valve
82	LR outrigger valve fault	LR outrigger valve fault	check the wiring, replace the valve
83	RF outrigger valve fault	RF outrigger valve fault	check the wiring, replace the valve
84	RR outrigger valve fault	RR outrigger valve fault	check the wiring, replace the valve
85	Extend outrigger valve fault	Extend outrigger valve fault	check the wiring, replace the valve
86	Retract outrigger valve fault	Retract outrigger valve fault	check the wiring, replace the valve
87	Steer Sensor Fault	Steer Sensor Fault	check the wiring, replace the Sensor
88	Test Mode	Test Mode	Close the test mode
OL	Overload fault	Platform Overload Fault	Remove the excess load immediately.
LL	Tilt fault	Machine Tilted Beyond Safe Limits Fault	check the wiring, replace the sensor

For more information, please consult the appropriate Dingli Service Dept.

**Hydraulic Schematic (JCPT1523DC)**

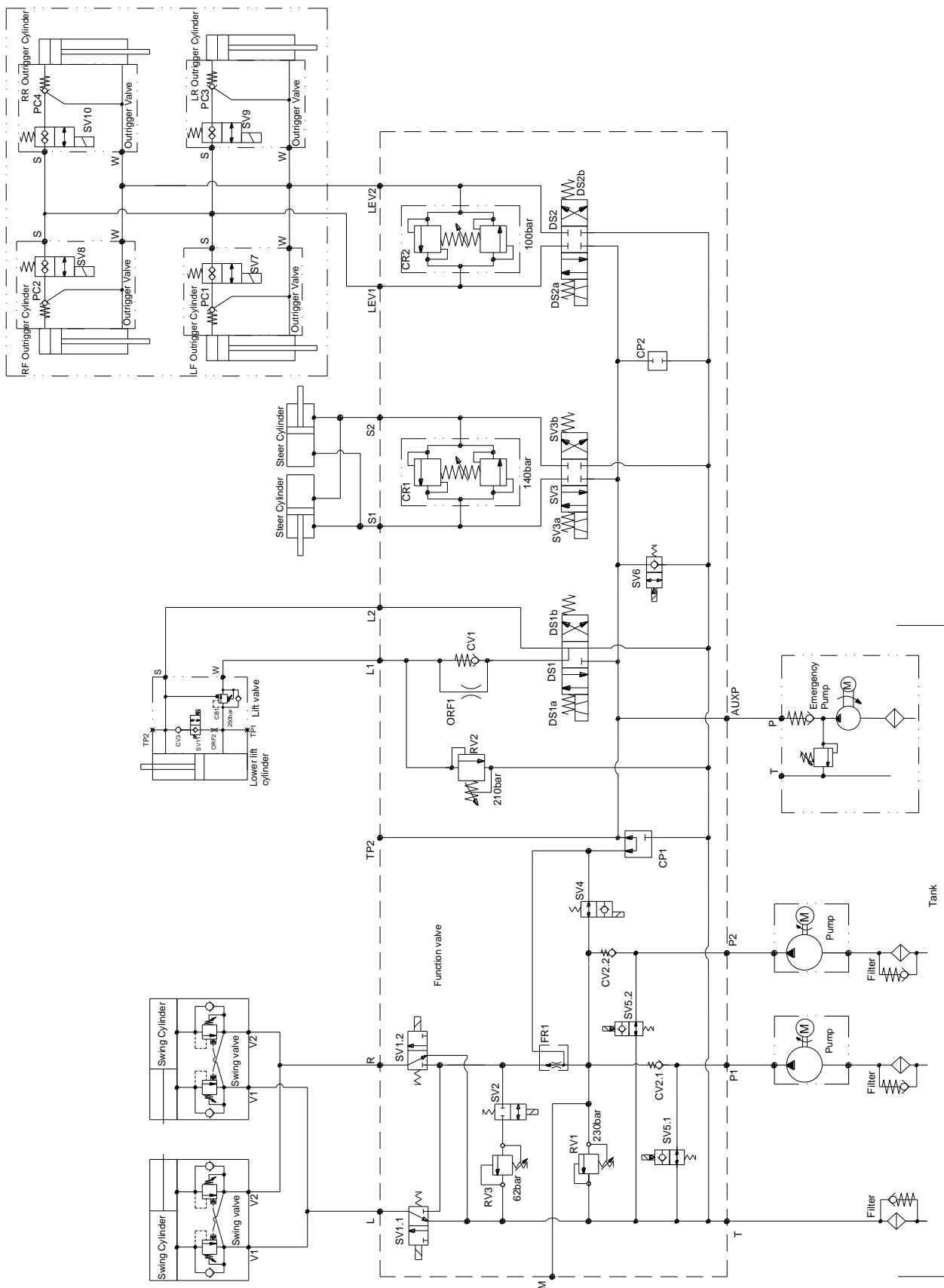

# Schematic

## Hydraulic Schematic (JCPT1823DC)

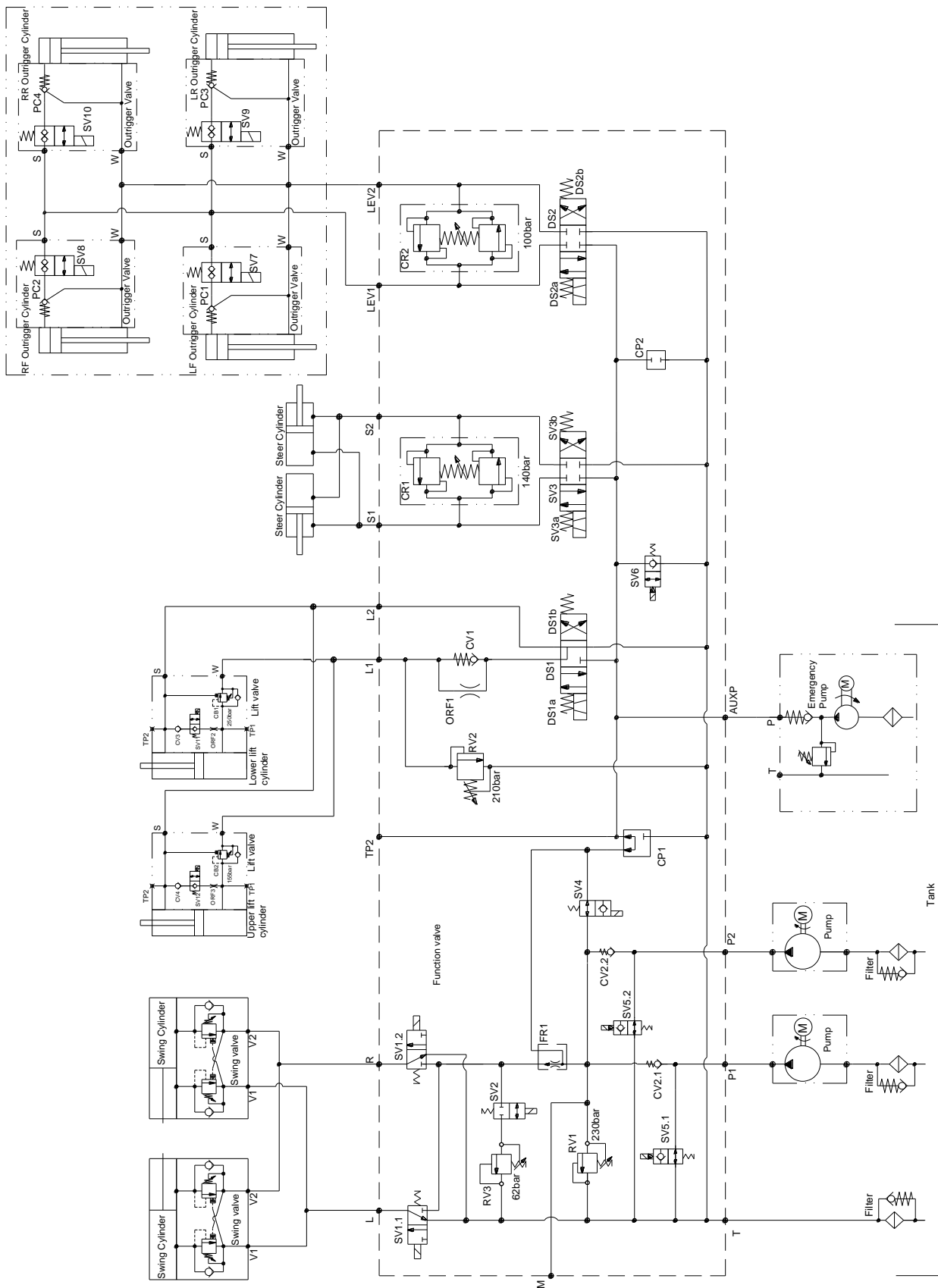

Electrical Schematic

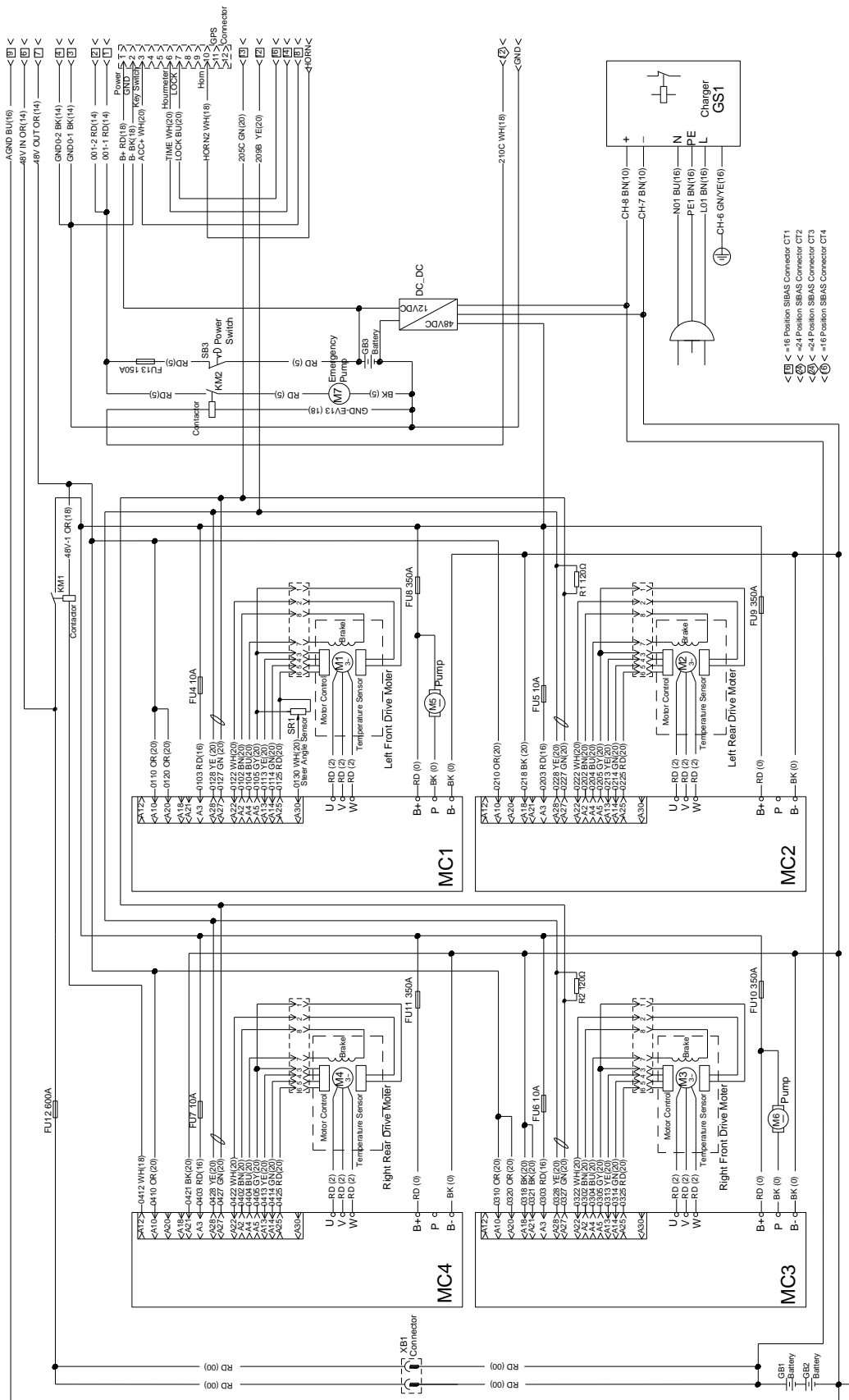



# Schematic

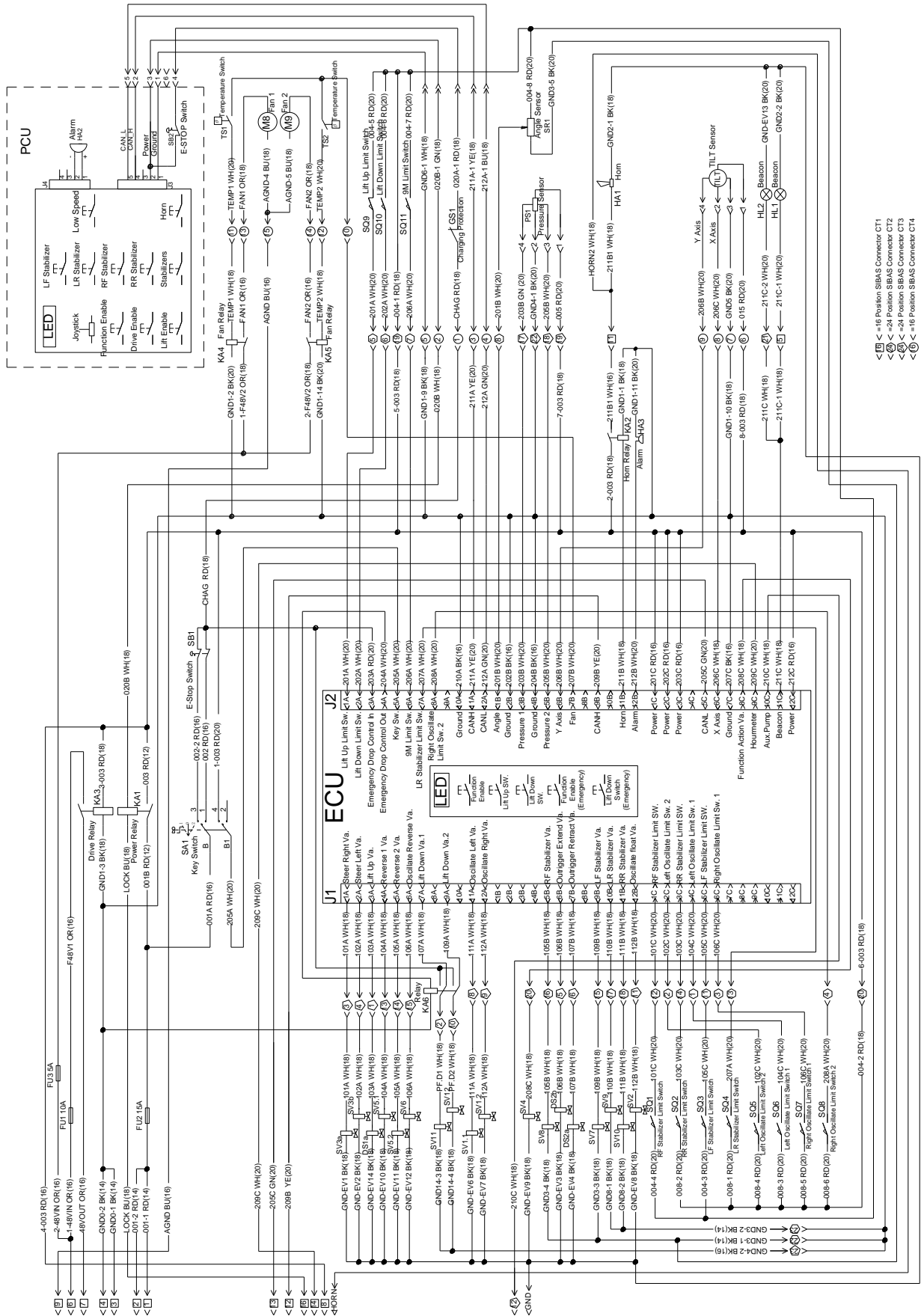

**Inspection and Repair Log****Inspection and Repair Log**

<b>Date</b>	<b>Comments</b>